

SINGER
61W34,W104

LIST OF PARTS



MACHINES

Nos. 61w34 and 61w104

THE SINGER MANUFACTURING COMPANY

INDEX

	PAGE
ACCESSORIES	16
BINDERS	26
BOBBIN WINDER	16
CORDERS	31
CORD COVERING ATTACHMENT	33
FEED DOGS	19
FOLDERS	34
HEMMERS	37
IRON BASE	45
KNEE LIFTER	17, 18
MACHINE No. 61w34	7
" " 61w104	15
NUMERICAL LIST OF PARTS	49
OBSOLETE PARTS	47
PLATTER	42
PRESSER FEET	20
RIBBON REELS	46
RUFFLER	44
THROAT PLATES	23
WOOD BASE	45

From the library of: Diamond Needle Corp

Instructions for Ordering

In ordering from this list, use **ONLY** the **PART** number in the **FIRST** column.

The number stamped on a Sewing Machine Part is the number of the Single Part only, except when the part includes Set Screws, Clamping Screws, Studs and Rollers Spun on, Small Wires riveted, or Parts soldered together, etc., which it is necessary to furnish in combination.

Every combination of parts sent out has its specific number which, although not stamped on Parts (except in above cases) must be used when ordering the combination.

Each number always indicates the **SAME PART** in whatever list it appears, or for whatever Machine.

The letters after some of the numbers indicate the style of finish only, as follows:

- A. Hardened, Polished and Plated.
- B. Polished and Plated.
- C. Hardened only.
- D. Polished only.
- E. Soft, not polished.
- F. Hardened and Polished.
- H. Blued.

These letters **MUST BE USED** when they appear in the list and **AFTER** the number, as in the list.

In this series

200001 to 201500 are Screw Numbers.

201501 to 201800 are Nut Numbers.

201801 to 202000 are Roller Numbers.

202001 and upward are numbers of Machine Parts.

The figures in the second column refer only to the plate in which the illustration of the part is shown and are **NOT TO BE USED** in ordering.

Two or more numbers over a cut indicate that the difference between such parts is not visible in an illustration.

Parts marked with an asterisk (*) are furnished only when repairs are made at the factory.

LIST OF PARTS COMPLETE

FOR

MACHINE No. 61w34

HAS MECHANICAL OPENER

For Shirts, Corsets, Underwear, Shirt Waists,
Flannels, Etc.

No.	Plate	Name
*202242	---	Arm
202247	10667	" Cap
200278H	10244	" " Screw
202248	10244	" " " Washer
204235	10668	" Position Pin (2)
200010E	10245	" Screw (3)
202005	10245	" " Washer (3)
202249	13351	" Shaft with 200357E and 203100
202243	13351	" " Bushing (back) with
		202244
202244	---	Arm Shaft Bushing (back) Oil
		Packing (wick)
200338C	10244	Arm Shaft Bushing (back) Set
		Screw
202245	10667	Arm Shaft Bushing (front) with
		202036 and 202260
202260	---	Arm Shaft Bushing (front) Oil
		Packing (wick)
200502B	10246	Arm Shaft Bushing (front) Oil
		Packing Thumb Screw
202036	10668	Arm Shaft Bushing (front) Posi-
		tion Pin
200338C	10244	Arm Shaft Bushing (front) Set
		Screw
202530	13351	Arm Shaft Connection Belt
202252	10244	" " " " Pulley
		with 200327C, 200602E and two
		202253
200602E	10244	Arm Shaft Connection Belt Pulley
		Position Screw
200327C	10244	Arm Shaft Connection Belt Pulley
		Set Screw
202253	10244	Arm Shaft Connection Belt Pulley
		Spring Flange

From the library of: Diamond Needle Corp

No.	Plate	Name
203100	---	Arm Shaft Oil Packing (wick) ...
200357E	10244	" " " " Stop Screw
202255	13351	Balance Wheel (belt groove 2½ in. diam.) with 200328c and 200335c
200328c	10244	Balance Wheel Position Screw ..
200335c	10244	" " Set Screw
*202532	---	Bed with 202872
202258	12153	" Hinge Connection (2)
200570E	10245	" " " Screw (4) ...
206753	13364	" Plate (back)
200577H	10245	" " " Screw
210616	10667	" Slide (front)
202265	11671	Bobbin
207057	13363	" Case Base
206733	---	" " Cap with 200592c, 201016c and 206738
206734	13363	Bobbin Case Cap complete, Nos. 200964c, 206733, 206736 and 210736
206735	13363	Bobbin Case Latch
206736	---	" " " 206735 with 206731 and 206737
206731	13363	Bobbin Case Latch Fulcrum Pin..
206737	13363	" " " Lever
210736	13363	" " " Spring
200964c	13363	" " " Stop Screw ...
206738	13363	" " Tension Spring
201016c	13363	" " " " Regulat- ing Screw
200592c	13363	Bobbin Case Tension Spring Screw
207058	13363	Bobbin Case complete, Nos. 206734 and 207057
202500	10273	Bobbin Case Lever
202501	10273	" " " Bushing
200333c	10273	" " " " Set Screw
206764	13363	" " " Driving Eccen- tric with 200380c and 200444c..
206763	---	Bobbin Case Lever Driving Eccen- tric 206764 with 200583H and 206761
206728	13363	Bobbin Case Lever Driving Eccen- tric Connection
206729	---	Bobbin Case Lever Driving Eccen- tric 206728 with 201194c, 201524c, 206758 and 206763
206730	13363	Bobbin Case Lever Driving Eccen- tric Connection Lever with 200086c

No.	Plate	Name
201194c	13363	Bobbin Case Lever Driving Eccen- tric Connection Lever Hinge Screw Stud
201524c	13363	Bobbin Case Lever Driving Eccen- tric Connection Lever Hinge Screw Stud Nut
206758	---	Bobbin Case Lever Driving Eccen- tric Connection Lever Oil Wick
200086c	10248	Bobbin Case Lever Driving Eccen- tric Connection Lever Pinch Screw
200380c	10272	Bobbin Case Lever Driving Eccen- tric Set Screw
200444c	10273	Bobbin Case Lever Driving Eccen- tric Spot Screw
206761	13363	Bobbin Case Lever Driving Eccen- tric Washer
200583H	10668	Bobbin Case Lever Driving Eccen- tric Washer Screw
207059	---	Bobbin Case Outfit complete, Nos. 200333c, 202500, 202501, 206729, 206730 and 207058
200459D	13353	Cloth Guide Thumb Screw
202274	10667	Face Plate
202135	10245	" " Position Pin
200462B	10245	" " Thumb Screw
202275	10667	Feed Bar
200641c	10246	" " Hinge Screw (driving)..
201522E	10246	" " " " Nut
202276	10245	" " Slide Block
202298	10245	" " " " Crank with 200038c
203124	---	Feed Bar Slide Block Crank 202298 with 200205E, 201518E and 202276
200038c	10245	Feed Bar Slide Block Crank Pinch Screw
200205E	10245	Feed Bar Slide Block Hinge Screw
201518E	10245	" " " " " " " " Nut
202282	10913	Feed Dog
200106E	10245	" " Screw (2)
202297	10667	" Driving Connection with 200054E and 202277
202298	10245	Feed Driving Connection Crank with 200038c
200038c	10245	Feed Driving Connection Crank Pinch Screw
200545c	10245	Feed Driving Connection Hinge Screw

No.	Plate	Name
201518E	10245	Feed Driving Connection Hinge Screw Nut
202277	—	Feed Driving Connection Oil Packing (wick)
200054E	13353	Feed Driving Connection Pinch Screw
202300	10246	Feed Driving Eccentric Regulating Bracket
203134	—	Feed Driving Eccentric Regulating Bracket 202300 with 202252, two each 201014c and 201525E
201014c	10245	Feed Driving Eccentric Regulating Bracket Hinge Screw
201525E	10245	Feed Driving Eccentric Regulating Bracket Hinge Screw Nut
202301	10246	Feed Driving Eccentric Regulating Bracket Plunger
202595	10246	Feed Driving Eccentric Regulating Bracket Plunger Spring
200607c	10244	Feed Driving Eccentric Regulating Bracket Plunger Spring Stop Screw
201014c	10245	Feed Driving Eccentric Regulating Bracket Stop Screw
201525E	10245	Feed Driving Eccentric Regulating Bracket Stop Screw Nut
200429c	10246	Feed Driving Eccentric Regulating Screw
200383c	10246	Feed Driving Eccentric Regulating Screw Check Screw
202303	13352	Feed Driving Rock Shaft
206860	—	“ “ “ “ 202303 with 200641c, 201522E and 202275
203121	—	Feed Driving Rock Shaft 206860 with 202282 and two 200106E..
202305	10245	Feed Driving Rock Shaft Center (2)
200043c	10246	Feed Driving Rock Shaft Center Set Screw (2)
202306	10667	Feed Lifting Connection with 200054E and 202277
202307	10246	Feed Lifting Connection Eccentric with 200382c and 200437c
200437c	10246	Feed Lifting Connection Eccentric Position Screw
200382c	10359	Feed Lifting Connection Eccentric Set Screw
200545c	10245	Feed Lifting Connection Hinge Screw

No.	Plate	Name
201518E	10245	Feed Lifting Connection Hinge Screw Nut
202277	—	Feed Lifting Connection Oil Packing (wick)
200054E	13353	Feed Lifting Connection Pinch Screw
202308	13352	Feed Lifting Rock Shaft
202305	10245	“ “ “ “ Center (2)
200043c	10246	“ “ “ “ “ Set Screw (2)
207070	13352	Feed Regulating Spindle with 202311, 202443, 202619 and 210554
*202311	—	Feed Regulating Spindle Head ...
202443	10244	“ “ “ “ Pin
202619	10668	“ “ “ “ Position Pin
210554	10668	Feed Regulating Spindle Spring (flat)
*206776	—	Hook (sewing)
206777	13352	“ 206776 with 200145H, 200596E, 200614c, 202320, 203101, 206751, 206775 and 206852
207060	13364	Hook and Bobbin Case complete, Nos. 206777 and 207058
206852	13353	Hook Gib
200614c	11671	“ “ Hinge Screw
200596E	11671	“ “ Screw
203101	—	“ Oil Wick
*202320	—	“ Shaft, 11 ⁷ / ₈ in. long
202321	10245	“ “ Bushing (back)
200346c	10245	“ “ “ “ Set Screw
202322	10245	“ “ “ “ (front)
200346c	10245	“ “ “ “ Set Screw
202323	10244	“ “ Connection Belt Pulley with 202324 and two 201018c ..
201018c	13353	Hook Shaft Connection Belt Pulley Set Screw
202324	10244	Hook Shaft Connection Belt Pulley Spring Flange
202260	—	Hook Shaft Oil Packing (wick) (2)
206775	11671	“ “ Pin
206751	11671	“ Washer
200145H	11671	“ “ Screw
202445	10936	Knee Lifter Connection Lever with 202446
202786	—	Knee Lifter Connection Lever 202445 with 200224H, 200262H, 202447 and 202449

No.	Plate	Name
200224H	10248	Knee Lifter Connection Lever Hinge Screw
202447	10936	Knee Lifter Connection Lever Lifting Rod with 202302
202302	10248	Knee Lifter Connection Lever Lifting Rod Cotter Pin
202446	10246	Knee Lifter Connection Lever Pin
202449	10936	" " Lifting Lever
200262H	10248	" " " " Hinge
202326	10248	Needle Bar with 200141F
202327	10248	" " Bushing
203123	—	" " " 202327 with 202326
200352C	10248	Needle Bar Bushing Set Screw ..
202331	10248	" " Connecting Link
202332	10668	" " " " Oil Guard
200161D	10247	Needle Bar Connecting Link Oil Guard Screw
202333	10248	Needle Bar Connecting Link Stud with 202254
202254	—	Needle Bar Connecting Link Stud Oil Packing (wick)
200374C	10668	Needle Bar Connecting Link Stud Set Screw
*206891	—	Needle Bar Connecting Stud
202329	10248	" " " " 206891 with 200086c and 202330
202330	—	Needle Bar Connecting Stud Oil Packing (wick)
200086c	10248	Needle Bar Connecting Stud Pinch Screw
202328	13352	Needle Bar Crank with 200335c, 200428c, 202333 and two 200374c
203117	—	Needle Bar Crank 202328 with 202329, 202331 and 202398 to 202400
203172	10248	Needle Bar Crank Friction Washer
200428c	10248	" " " Position Screw ..
200335c	10244	" " " Set Screw
200141F	10248	" Set Screw
202335	10667	Presser Bar (hollow) with 200074F
207072	10249	" " Bushing
200352C	10248	" " " Set Screw
202339	10249	" " Lifter
200653c	10249	" " " Hinge Screw
202340	10249	" " Lifting Releasing Lever Bracket

No.	Plate	Name
200260D	10249	Presser Bar Lifting Releasing Lever Bracket Guide Screw
202342	10249	Presser Bar Lifting Releasing Lever Bracket Spring (spiral)
202337	10249	Presser Bar Position Guide
202338	10249	" " " " Lever with 200086F
200086F	10248	Presser Bar Position Guide Lever Pinch Screw
200352C	10248	Presser Bar Position Guide Set Screw
202343	13353	Presser Bar Spring (light)
202346	10249	" " " Stop Rod
200492B	10249	" " Thumb Screw (pressure regulating)
200475B	10668	Presser Bar Thumb Screw Thumb Set Screw
202355	10668	Presser Bar Thumb Screw Thumb Set Screw Packing (brass)
202418	10929	Presser Foot
200074F	10249	" " Screw
202068	12153	Spool Holder Base
200575H	10668	" " " Screw
204296	12153	" " Wire
200079H	10668	" " " Hinge Screw ...
204297	12153	Spool Holder complete, Nos. 200079H, 202068 and 204296
202397	10668	Take-up (auxiliary)
200842F	10668	" " Screw
202398	10247	" Lever
202399	10247	" " Driving Stud with 202277
202277	—	Take-up Lever Driving Stud Oil Packing (wick)
202400	10247	Take-up Lever Hinge Stud with 202423
202423	—	Take-up Lever Hinge Stud Oil Packing (wick)
200383C	10246	Take-up Lever Hinge Stud Set Screw
202401	10247	Take-up Lever Oiling Felt
200132F	10247	" " " " Screw .
202402	10247	Tension Disc (back)
202403	10247	" " (front)
202404	10247	" Release Plunger
202405	10247	" " Washer
202407	10247	" Spring
200625F	10247	" Stud with 204925
200084C	—	" " Set Screw

No.	Plate	Name
204925	10668	Tension Stud Washer
201572B	10881	" Thumb Nut
202409	10252	Tension complete, Nos. 200625F, 201572B, 202402, 202403, 202405, 202407 and 202410
202410	10252	Thread Controller Spring
202411	10252	" " " Stop
200132E	10247	" " " " Screw
202413	10252	" Guide
202414	10252	" "
202415	10252	" "
202417	10252	" "
200582H	10252	" " Screw
200355H	10272	" " Set Screw
200368H	10668	" " " "
202091	10252	" Retainer Sleeve
202092	10252	" " Spring
204058	10252	" " Stud
200368H	10668	" " " Set Screw
204059	10668	Thread Retainer complete, Nos. 202091, 202092 and 204058
202818	13354	Throat Plate, 50 needle hole, for needle sizes 14 and 15, with 202534, 202619 and two 200583H
202534	10390	Throat Plate Bobbin Case Stop ...
202619	10668	" " " " " Posi- tion Pin
200583H	10668	Throat Plate Bobbin Case Stop Screw
202872	10668	Throat Plate Position Pin
200577H	10245	" " Screw (2)

MACHINE No. 61w104

HAS MECHANICAL OPENER

For Shirts, Corsets, Underwear, Shirt Waists,
Flannels, Etc.

This Machine is the same as No. 61w34 with the
following exceptions:

No.	Plate	Name
*202241	---	Arm, in place of 202242
202250	13365	" Shaft with 200357E and 203100, in place of 202249
*206897	-----	Bed with 202872, in place of 202532
202304	13365	Feed Driving Rock Shaft, in place of 202303
203122	-----	Feed Driving Rock Shaft 202304 with 200641c, 201522E and 202275, in place of 206860
202654	13365	Feed Lifting Rock Shaft, in place of 202308
206754	13365	Hook 206776 with 200145H, 200596F, 200614c, 202319, 203101, 206751, 206775 and 206852, in place of 206777
207061	13365	Hook and Bobbin Case complete, Nos. 206754 and 207058, in place of 207060
*202319	-----	Hook Shaft, 13 $\frac{3}{4}$ in. long, in place of 202320
202732	----	Knee Lifter Connection Lever 202445 with 200224H, 200262H, 202447 and 202448, in place of 202786
202448	10936	Knee Lifter Lifting Lever, in place of 202449

From the library of: Diamond Needle Corp

ACCESSORIES

FOR MACHINE NO. 61w34

No.	Plate	Name
200157B	13353	Attachment Screw
202265	11671	Bobbin (5)
*225482	—	Bobbin Case Screw Driver Blade ..
*225483	—	“ “ “ “ Handle ..
225497	12153	Bobbin Case Screw Driver complete, Nos. 225482 and 225483 ..
231337	13353	Cloth Guide
135 x 1	—	Needles, three each, sizes 12 and 14
225180	—	Drip Pan (short) with four wood screws $\frac{1}{2}$ in., No. 5
41400	12153	Machine Rest Pin (wood)
36578	12153	Oiler with 36579
36579	12153	“ Spout, $3\frac{1}{2}$ in. long, with 120117 ..
120117	—	“ “ Washer
*225484	—	Screw Driver Blade
*225485	—	“ “ Handle
225498	12153	Screw Driver complete ($7\frac{1}{4}$ in. long), Nos. 225484 and 225485 ..
225554	12153	Wrench (steel)

BOBBIN WINDER

Swing Automatic, Right Hand

*225451	—	Bobbin Holder
225453	10882	Frame with 202277 and 225438
225454	10882	“ Hinge Pin
202277	—	“ Oil Packing (wick)
225438	10882	“ “ Well Cap
225455	10882	“ Spring
225456	10882	“ “ Plunger
202473	10883	Pulley with 200380c
200380c	11614	“ Set Screw
*225443	—	Spindle
225452	10882	“ 225443 with 225451
225444	10882	Stop Latch
200056E	10882	“ “ Screw
225458	10882	“ “ Thumb Lever
225459	10882	“ “ “ “ Hinge Stud ..
225460	10882	“ “ “ “ Joint Stud ..
202478	10882	“ “ Trip Lever
200299H	10882	“ “ “ “ Hinge Screw ..

No.	Plate	Name
225461	10881	Tension Bracket with 201499B ...
200082D	10881	“ “ Screw
202104	10881	“ “ “ Washer
2102	10881	“ Disc
202407	10881	“ Spring
201499B	10881	“ Stud
201572B	10881	“ “ Thumb Nut
225462	10881	Bobbin Winder Tension Bracket complete, Nos. 201572B, 202407, 225461 and two 2102
225463	10883	Bobbin Winder and Tension Bracket Base
225436	10883	Universal Bobbin Winder complete, Nos. 200056E, 200082D, 200299H, 202104, 202473, 202478, 225444, 225452 to 225456, 225458 to 225460, 225462, 225463 and two wood screws $\frac{3}{4}$ in., No. 13, R.H.B.

KNEE LIFTER

227781	10936	Knee Lifter Rock Lever with 200522c and 200529c
227782	—	Knee Lifter Rock Lever 227781 with two each 202451 and 202452 ..
227783	—	Knee Lifter Rock Lever 227782 with 202985 and 227784
202453	10936	Knee Lifter Rock Lever Knee Plate with 200526c
202985	—	Knee Lifter Rock Lever Knee Plate 202453 with 202455
202455	10936	Knee Lifter Rock Lever Knee Plate Arm (short)
200522c	13353	Knee Lifter Rock Lever Knee Plate Arm Set Screw
200526c	13353	Knee Lifter Rock Lever Knee Plate Set Screw
202451	10936	Knee Lifter Rock Lever Lug with two wood screws $\frac{1}{4}$ in., No. 13H ..
202452	13353	Knee Lifter Rock Lever Lug Hinge Pin
227784	10936	Knee Lifter Rock Lever Rod, 3 in. long, with 227785
*227785	—	Knee Lifter Rock Lever Rod Cap or Oil Guard
200529c	13353	Knee Lifter Rock Lever Rod Set Screw

(Other Knee Lifter Parts are listed with parts of machine head.)

FOR MACHINE NO. 61w104

Same as for No. 61w34 with the following exceptions:

No.	Plate	Name
225191	----	Drip Pan (long) with four wood screws $\frac{1}{2}$ in., No. 5, in place of 225180
KNEE LIFTER		
227781	10936	Knee Lifter Rock Lever with 200522c and 200529c
227782	----	Knee Lifter Rock Lever 227781 with two each 202451 and 202452
227787	----	Knee Lifter Rock Lever 227782 with 202203 and 227784
202453	10936	Knee Lifter Rock Lever Knee Plate with 200526c
202203	----	Knee Lifter Rock Lever Knee Plate 202453 with 202454
202454	10936	Knee Lifter Rock Lever Knee Plate Arm (long)
200522c	13353	Knee Lifter Rock Lever Knee Plate Arm Set Screw
200526c	13353	Knee Lifter Rock Lever Knee Plate Set Screw
202451	10936	Knee Lifter Rock Lever Lug with two wood screws $\frac{3}{4}$ in., No. 13H
202452	13353	Knee Lifter Rock Lever Lug Hinge Pin
227784	10936	Knee Lifter Rock Lever Rod, 3 in. long, with 227785
*227785	----	Knee Lifter Rock Lever Rod Cap or Oil Guard
200529c	13353	Knee Lifter Rock Lever Rod Set Screw

(Other Knee Lifter Parts are listed with parts of machine head.)

FEED DOGS

No.	Plate	Name
202278	10913	Feed Dog, for 202811 and 225996..
202281	10913	" " " 202815
202282	10913	" " " general muslin work, for 202818, 202951, 203073 and 203113
202283	10913	Feed Dog, for 202819
202284	10913	" " " 202812, 226197, 226215 and 226239
202287	10913	Feed Dog, for muslin work and gathering, for 202822
202289	10913	Feed Dog, for 202817
202290	10912	" " " special work, for 202824
202293	10912	Feed Dog, for 202827 and 225979..
202294	10912	" " " 202828 and 202832..
202295	10912	" " " tucking work, for 202829
202296	10912	Feed Dog, for 202831
202813	10312	" " " 202820
202970	10912	" " " 202969
203071	10912	" " " 203056 and 206975..
203072	10912	" " " 203053
203083	10912	" " " 203063
203136	13354	" " " 202816
203417	13354	" " " 203111
206802	10314	" " " 206804 and 226024..
207051	10915	" " " handkerchief hemming, knit goods and shoe lining, for 202819
207052	10915	Feed Dog, for handkerchief hemming, knit goods and shoe lining, for 202819
207053	10915	Feed Dog, for shirt, collar and cuff work, for 202817
207054	10915	Feed Dog, for shirt, collar and cuff work, for 202817
207055	10915	Feed Dog, for general muslin work, for 202818, 202951, 203073 and 203113
207056	10915	Feed Dog, for general muslin work, for 202818, 202951, 203073 and 203113
225977	10310	Feed Dog, for 225622
230625	13354	" " " 230749, 230751 and 230833

PRESSER FEET

No.	Plate	Name
26608	13355	Presser Foot (glass)
202354	10926	" " for $\frac{3}{8}$, $\frac{1}{8}$ and $\frac{3}{16}$ in. stitching margins, for collar and cuff work
202356	10263	Presser Foot, for binding
202361	10926	" " " "
202368	10259	" " (deep grooved) (grooved to left of needle hole), from 4 to 16 cords to the in., as ordered, for top cording
202369	10259	Presser Foot (deep grooved) (grooved to left of needle hole), from 4 to 16 cords to the in., as ordered, for top cording
202370	10259	Presser Foot (deep grooved) (grooved to right of needle hole), from 4 to 16 cords to the in., as ordered, for top cording
202373	13355	Presser Foot, for gathering
202375	10926	" " " mattress binding
202376	10926	" " " " " "
202390	10263	" " " front steel stitching in corset work
202418	10929	Presser Foot
202529	10926	" " (split), for gathering
203179	10926	" " for $\frac{1}{8}$ in. stitching margin, for collar and cuff work
203198	13355	Presser Foot, for laying tucks
203199	13355	" " " narrow tucks
203200	13355	" " " tucks toward the needle
206528	10925	Presser Foot, for stitching margins $\frac{3}{16}$, $\frac{1}{8}$ and $\frac{3}{16}$ inch
206779	13355	Presser Foot
206785	10929	" "
206786	10929	" " (split)
206787	13355	" " for stitching margins from $\frac{3}{16}$ to $\frac{1}{4}$ in., in steps of $\frac{1}{32}$ inch
206788	10929	Presser Foot
206791	10925	" " for use with English Binder
206792	10925	Presser Foot, for stitching margins from $\frac{1}{8}$ to $\frac{1}{4}$ in., in steps of $\frac{1}{16}$ inch

No.	Plate	Name
206794	10929	Presser Foot, for tailoring work..
206841	13355	" " " binding
225508	10923	" " " puckering and gathering
225621	10310	Presser Foot
225690	10923	Presser Foot, from 4 to 16 cords to the in., as ordered, for top and bottom cording
225702	13356	Presser Foot, for welts
225723	10926	" " " "
225792	10350	" " " "
225798	10353	" " " "
225862	13356	" " for stitching margins from $\frac{1}{8}$ to $\frac{1}{4}$ in., in steps of $\frac{1}{16}$ in., for collar and cuff work
225949	13356	Presser Foot, for welts
226029	10923	" " " darning
229597	10925	" " " stitching margins from $\frac{1}{4}$ to $\frac{3}{8}$ in., in steps of $\frac{1}{16}$ in., for open bosom shirts
229856	10929	Presser Foot
229857	10929	" " " "
229858	10929	" " " "
229880	13356	" " for binding suspenders
230745	14650	Presser Foot, for cord covering ..
206842	13356	" " Cleft Holder
206998	13356	" " Holder with 200543H, for Presser Bar 202335 as a substitute for Compound Presser Bar 202514
200543H	13356	Presser Foot Screw
202366	10926	" " for stitching margins $\frac{3}{16}$, $\frac{1}{8}$, $\frac{3}{16}$, $\frac{1}{4}$, $\frac{3}{16}$ and $\frac{1}{8}$ in., with 200175H and 202810
206790	10927	Presser Foot, for stitching margins from $\frac{1}{8}$ to $\frac{1}{4}$ in., in steps of $\frac{1}{16}$ in., with 200904E and 202809
229871	10925	Presser Foot (right hand spring guide), stitching margins from $\frac{3}{16}$ to $\frac{1}{4}$ in., in steps of $\frac{1}{16}$ in., with 200175H and 202807. Order margin required
202809	10927	Presser Foot Adjustable Spring Guide
200904E	13356	Presser Foot Adjustable Spring Guide Screw
202807	10925	Presser Foot Spring Guide
202810	10926	" " " " " "
200175H	10360	" " " " " Screw ..

No.	Plate	Name
203037	—	Presser Foot Plate with 231235 to 231237 and six 200175H
202572	13356	Presser Foot Hinge Pin
231235	—	" " Strip Guide with 200488c
231236	—	Presser Foot Strip Guide Bar
231237	—	" " " " " Plate
200175H	10360	" " " " " " Screw
200488c	—	Presser Foot Strip Guide Thumb Screw
231238	13355	Presser Foot (hinged) (adjustable) complete, for strips $\frac{3}{8}$ to $1\frac{1}{4}$ in., Nos. 202572, 202924 and 203037, for stitching shoe facings
202090	13356	Presser Foot Hinge Pin
203009	—	" " Plate, for 229864
203010	—	" " " " 229863
203011	—	" " " " 229867
203012	—	" " " " 229868
203024	—	" " " " 229865
203034	—	" " " " 202372
203035	—	" " " " 202371
203322	—	" " " " 203323
229055	—	" " " " 202351
202924	—	" " Shank
202351	10927	Presser Foot (hinged) complete, Nos. 202090, 202924 and 229055, for knit goods
202371	13356	Presser Foot (hinged) complete, Nos. 202090, 202924 and 203035 ..
202372	13356	Presser Foot (hinged) complete, Nos. 202090, 202924 and 203034, for handkerchief hemming
203323	13356	Presser Foot (hinged) complete, Nos. 202090, 202924 and 203322 ..
229863	10927	Presser Foot (hinged) complete, Nos. 202090, 202924 and 203010, for overalls and tailoring
229864	10927	Presser Foot (hinged) complete, Nos. 202090, 202924 and 203009 ..
229865	10929	Presser Foot (hinged) complete, Nos. 202090, 202924 and 203024, for tailoring
229867	10927	Presser Foot (hinged) complete, Nos. 202090, 202924 and 203011, for overalls
229868	10927	Presser Foot (hinged) complete, Nos. 202090, 202924 and 203012 ..

THROAT PLATES

No.	Plate	Name
202811	13354	Throat Plate, 50 needle hole, for needle sizes 14 and 15, with 202534, 202619 and two 200582H, for 202278 and 225996
202812	10390	Throat Plate, 46 needle hole, for needle sizes 16 and 18, with 202534, 202619 and two 200583H, for 202284, 226197, 226215 and 226239
202815	10391	Throat Plate, 53 needle hole, for needle sizes 12 and 13, with 202534, 202619 and two 200583H, for tucking work, for 202281
202816	10391	Throat Plate, 50 needle hole, for needle sizes 14 and 15 , with 202534, 202619 and two 200582H, for 203136
202817	10391	Throat Plate, 60 needle hole, for needle sizes 8 and 9, with 202534, 202619 and two 200583H, for fine shirt work, for 202289, 207053 and 207054
202818	13354	Throat Plate, 50 needle hole, for needle sizes 14 and 15, with 202534, 202619 and two 200583H, for 202282, 207055 and 207056 ...
202819	10391	Throat Plate, 50 needle hole, for needle sizes 14 and 15, with 202534, 202619 and two 200583H, for 202283, 207051 and 207052 ...
202820	10391	Throat Plate, 50 needle hole, for needle sizes 14 and 15, with 202534, 202619 and two 200583H, for 202813
202822	10391	Throat Plate, 50 needle hole, for needle sizes 14 and 15, with 202534, 202619 and two 200583H, for muslin work and gathering, for 202287
202824	10390	Throat Plate, 50 needle hole, for needle sizes 14 and 15, with 202534, 202619 and two 200583H, for special work, for 202290

No.	Plate	Name
202827	10390	Throat Plate, 53 needle hole, for needle sizes 12 and 13, with 202534, 202619 and two 200583u, for 202293 and 225979
202828	13354	Throat Plate, 53 needle hole, for needle sizes 12 and 13, with 202534, 202619 and two 200583u, for tucking with Tuck Folder, for 202294
202829	10390	Throat Plate, 53 needle hole, for needle sizes 12 and 13, with 202534, 202619 and two 200583u, for special tucking, for 202295 ..
202831	10391	Throat Plate, 50 needle hole, for needle sizes 14 and 15, with 202534, 202619 and two 200582u, for 202296 and 226100
202951	13357	Throat Plate, 56 needle hole, for needle sizes 10 and 11, with 202534, 202619 and two 200583u, for 202282, 207055 and 207056 ..
202969	10917	Throat Plate, 50 needle hole, for needle sizes 14 and 15, with 202534, 202619 and two 200583u, for fine shirt work, for 202970 ..
203053	10917	Throat Plate, 53 needle hole, for needle sizes 12 and 13, with 202534, 202619 and two 200583u, for 203072
203056	10917	Throat Plate, 50 needle hole, for needle sizes 14 and 15, with 202534, 202619 and two 200583u, for tucking, for 203071
203063	10917	Throat Plate, 50 needle hole, for needle sizes 14 and 15, with 202534, 202619 and two 200582u, for special work, for 203083
203073	10917	Throat Plate, 46 needle hole, for needle sizes 16 and 18, with 202534, 202619 and two 200583u, for 202282, 207055 and 207056 ...
203111	13357	Throat Plate, 50 needle hole, for needle sizes 14 and 15, with 202534, 202619 and two 200583u, for regular cloth work, for 203417
203113	13357	Throat Plate, 40 needle hole, for needle sizes 20 and 22, with 202534, 202619 and two 200583u, for general muslin work, for 202282, 207055 and 207056

No.	Plate	Name
206975	13357	Throat Plate, 50 needle hole, for needle sizes 14 and 15, with 202534, 202619 and two 200583u, for 203071
206804	10314	Throat Plate, 50 needle hole, for needle sizes 14 and 15, with 202534, 202619 and two 200583u, for 206802 and 226024
225622	10310	Throat Plate, 53 needle hole, for needle sizes 12 and 13, with 202534, 202619 and two 200582u, for 225977
226000	13357	Throat Plate, 53 needle hole, for needle sizes 12 and 13, with 202534, 202619 and two 200583u, for top and bottom cording, for 203173
230833	13357	Throat Plate, 50 needle hole, for needle sizes 14 and 15, with 201566u, 202534 and two 200583u. Used with Cord Covering Attachment, for 230625
230749	14650	Throat Plate, 50 needle hole, for needle sizes 14 and 15, with 201566u, 202534 and two 200583u, for 230625 and 230751
201566u	13357	Cord and Strip Folder Thumb Nut, for 230749 and 230833
200582u	10252	Throat Plate Bobbin Case Stop Screw

BINDERS

No.	Plate	Name
225646	10316	Binder on Shank, for tapes from $\frac{1}{2}$ to 1 in., in steps of $\frac{1}{16}$ inch .. Note: State width required, send samples of material to be bound and sufficient tape to test Binder.
225659	10316	Bias Binder on Shank, for binding from $\frac{3}{8}$ to 1 in., in seps of $\frac{1}{16}$ inch .. Note: State width required, send samples of material to be bound and sufficient binding to test Binder.

BINDER

For Tapes or Folder Strips Without Seams

225624	11598	Binder on Shank, for tapes $\frac{1}{2}$, $\frac{3}{8}$, $\frac{5}{16}$, $\frac{3}{16}$, $\frac{1}{4}$, $\frac{1}{8}$ and 1 inch Note: State width required, send samples of material to be bound and sufficient tape to test Binder.
--------	-------	---

ENGLISH BINDER

202278	10913	Feed Dog
225647	10315	Binder Head, made for tapes or folded strips from $\frac{1}{4}$ to $\frac{3}{4}$ in., in steps of $\frac{1}{16}$ inch .. Note: State width required, send samples of material to be bound and sufficient material to test Folder.
225650	10315	Binder complete, Nos. 225647, 225649, 230251 and two 200155F
200155F	10315	Binder Screw
230251	11598	" " Washer
206779	13355	Presser Foot
225648	10315	Ribbon Tension Pin
225649	10315	" " Plate with seven 225648
202811	13354	Throat Plate, 50 needle hole, for needle sizes 14 and 15, with 202534, 202619 and two 200582H
225996	---	Binder Combination complete, Nos. 202278, 202811, 206779 and 225650

BOSTON BINDER

For Shoes and Slippers

No.	Plate	Name
225630	10312	Binder on Shank, for tapes from $\frac{1}{4}$ to 1 in., in steps of $\frac{1}{16}$ inch .. Note: State width required, send samples of material to be bound and sufficient tape to test Binder.
225631	10312	Binder on Shank with Shank extending beyond Binder, for tapes of the following widths: $\frac{3}{8}$, $\frac{7}{16}$, $\frac{1}{2}$, $\frac{9}{16}$, $\frac{5}{8}$, $\frac{11}{16}$, $\frac{3}{4}$, $\frac{13}{16}$, $\frac{7}{8}$, $\frac{15}{16}$ and 1 inch
202283	10913	Feed Dog
202356	10263	Presser Foot
202819	10391	Throat Plate, 50 needle hole, for needle sizes 14 and 15, with 202534, 202619 and two 200583H

BINDERS

For Dress Shields

226170	13351	Bed Slide (back) with 226015
226015	14650	" " Ribbon Tension Pin
200861B	11598	" " Thumb Screw
225628	11598	Binder on Shank, for $\frac{1}{16}$ in. tape binding
202284	10913	Feed Dog
206841	13355	Presser Foot
226238	---	Ribbon Reel (holding projection, 6 in. diam.) with 226212 and 226213
225663	10321	Ribbon Reel (9 in. diam.) with 225666 and three 205520
226211	---	Ribbon Reel (holding projection, 6 $\frac{3}{4}$ in. diam.) with 226212 and 226213
226212	11598	Ribbon Reel Center Pin
226213	11598	" " " " Washer ..
225664	11598	" " Supporting Spindle ..
225665	---	" " " " Base with 225664 and two wood screws $\frac{3}{8}$ in., No. 7
230471	---	Ribbon Reel Supporting Spindle Hub
225666	---	Ribbon Reel Supporting Spindle Hub 230471 with 225980
225980	---	Ribbon Reel Supporting Spindle Hub Base

No.	Plate	Name
205520	11598	Ribbon Reel Supporting Spindle Hub Base Rivet
225976	---	Ribbon Reel (9 in. diam.) complete, Nos. 225663 and 225665
202812	10390	Throat Plate, 46 needle hole, for needle sizes 16 and 18, with 202534, 202619 and two 200583H
226197	---	Dress Shield Binder complete, Nos. 202284, 202812, 206841, 225628, 225976 and 226170
226215	---	Dress Shield Binder complete, Nos. 200861B, 202284, 202812, 206841, 225628, 226170 and 22611
226239	---	Dress Shield Binder complete, Nos. 200861B, 202284, 202812, 206841, 225628, 226170 and 226238

BINDER (Adjustable)**For Hats**

225610	10309	Bed
225612	10309	Folder with 225610
225613	10309	" Slide with 200768E
200768E	10309	" " Adjusting Screw
225614	10309	" " " Thumb Nut Guide
226077	---	" " " " " "
		225614 with 226112
200164B	10309	Folder Slide Adjusting Thumb Nut Guide Screw
226112	10309	Folder Slide Adjusting Thumb Nut Sleeve with 225998
225998	10309	Folder Slide Adjusting Thumb Nut Sleeve Screw Center
225615	10309	Folder Slide Cap
200164B	10309	" " " Screw
225616	10309	Guide (front)
200893D	11598	" " Thumb Screw
225618	10309	" (back, lower)
225619	10309	" (back, upper)
200893D	11598	" (back) Thumb Screw
225620	10309	Pressure Spring
200176D	11598	" " Screw
225623	10310	Binder complete, Nos. 200176D, 225612, 225613, 225615, 225616, 225618 to 225620, 226077, two each 200164B and 200893D
225977	10310	Feed Dog
225621	10310	Presser Foot

No.	Plate	Name
225622	10310	Throat Plate, 53 needle hole, for needle sizes 12 and 13, with 202534, 202619 and two 200582H
Note: Nos. 225621, 225622 and 225977 should be used with but not included in No. 225623.		

BINDER**For Suspender Tabs**

225633	10312	Binder on Shank, in sizes $\frac{1}{2}$ and $\frac{3}{8}$ inch
202813	10312	Feed Dog
229880	13356	Presser Foot
202820	10391	Throat Plate, 50 needle hole, for needle sizes 14 and 15, with 202534, 202619 and two 200583H

BINDER (Bias)

225634	10312	Binder on Shank, for $\frac{1}{2}$, $\frac{3}{8}$ and $\frac{5}{8}$ inch
--------	-------	--

BINDER FOR CIRCULAR BINDING**(Bias Binding)****For Suspender Ends and Tabs, with Movable Folder
for Finishing Off**

225637	10314	Binder on Shank, for strips of dif- ferent widths from $\frac{1}{2}$ to $\frac{5}{8}$ inch Note: State width required, send samples of material to be bound and sufficient strip to test Binder.
225645	10313	Binder 225637 with 200462B, 200472B, 201527E, 206053, 225638, 225640, 225641, two each 200313F and 202104
200313F	10313	Binder Hinge Screw
202104	10881	" " " Washer
225638	10314	" Plate with 225706
200462B	10245	" " Thumb Screw
201527E	10313	" " " " Nut
206053	10313	" Spring
225640	10314	" " Hook
200313F	10313	" " " Adjusting Screw
202104	10881	" " " " " "
		Washer

No.	Plate	Name
200472B	10313	Binder Spring Thumb Screw
225641	10314	" Stop
225706	10313	" " Position Stud
206802	10314	Feed Dog
229880	13356	Presser Foot
206804	10314	Throat Plate, 50 needle hole, for needle sizes 14 and 15, with 202534, 202619 and two 200583H
226024	---	Binder complete, Nos. 206802, 206804, 225645 and 229880

CORDERS

WHEN ORDERING SEND SAMPLES OF CORD

CORDER

For Top Cording

For 8, 9, 10, 12, 14, or 16 cords to the inch, as ordered

No.	Plate	Name
225684	10322	Arm with 200340c, 201533E and three 225686
200340c	11598	Arm Adjusting Screw
201533E	11598	" " " Nut
225685	10322	" Bracket with 200851B
225687	10322	" " Hinge Pin
200851B	10322	" " Locking Thumb Screw
200035E	11598	" " Screw
225689	10322	" " " Clamp Washer ..
225686	10322	" Cord Guide
225688	11599	Arm and Bracket complete, Nos. 225684, 225685, 225687, 225689 and two 200035E
203136	13354	Feed Dog
202816	10391	Throat Plate, 50 needle hole, for needle sizes 14 and 15, with 202534, 202619 and two 200582H

CORDER

For Top and Bottom Cording

For 8, 9, 10, 12, 14, or 16 cords to the inch, as ordered

225688	11599	Arm and Bracket complete, Nos. 225684, 225685, 225687, 225689 and two 200035E
203173	13354	Feed Dog
225690	10923	Presser Foot
226000	13357	Throat Plate, 53 needle hole, for needle sizes 12 and 13, with 202534, 202619 and two 200583H

BOW CORDER

For Sunbonnets, Etc.

225693	10325	Presser Foot and Bracket
--------	-------	--------------------------------

Note: When ordering 225693 send sample cord.

No.	Plate	Name
225695	----	Presser Foot Bracket Bow, 8 in. long, with 225698 and 231149 ..
225698	10325	Presser Foot Bracket Bow Cord Tube (order size wanted)
231149	----	Presser Foot Bracket Bow Cord Tube (short)
200185D	10325	Presser Foot Bracket Bow Screw
206482	11598	" " " " " "
		Washer
225699	10325	Corder, 8 in. bow, complete, Nos. 225693, 225695, two each 200185D and 206482

BOW CORDER**For Infants' Caps, Etc.**

225696	10325	Presser Foot Bracket Bow, 6 in. long, with 225698 and 231149 ...
225930	10325	Corder, 6 in. bow, complete, Nos. 225693, 225696, two each 200185D and 206482

BOW CORDER**For Extra Fine Work**

225697	----	Presser Foot Bracket Bow, 4 in. long, with 225698 and 231149 ...
225940	10325	Corder, 4 in. bow, complete, Nos. 225693, 225697, two each 200185D and 206482

Note: When ordering 225699, 225930 or 225940 send sample of cord on material to be used.

CORD COVERING ATTACHMENT

No.	Plate	Name
230744	14650	Cord Guide and Strip Folder
200137D	10359	" " " " " Screw
201566B	13357	" " " " " Thumb Nut
230625	13354	Feed Dog
230745	14650	Presser Foot
35983	11598	Strip Wire
230746	14650	Tape Tension Frame with six 226015
226015	14650	Tape Tension Pin
230749	14650	Throat Plate, 50 needle hole, for needle sizes 14 and 15, with 201566B, 202534 and two 200583H
230751	----	Cord Covering Attachment complete, Nos. 35983, 200137D, 230625, 230744 to 230746 and 230749

FOLDERS

For Open Shirt Fronts

No.	Plate	Name
226165	10923	Presser Folder, for folding a $\frac{1}{8}$ in. fold from the left which is to be stitched near the edge

FOLDERS (Double)

For Shirt Work

225729	11598	Folder, turns the upper edge under and the under edge over, for H, XH, XXH or XXXH material ..
225962	10511	Folder on Shank, folds the top goods under and the under goods over and guides a piece of goods between them from the left

Note: Send sample of goods to be folded.

BENCH TUCK FOLDER

202293	10912	Feed Dog
203198	13355	Presser Foot, for laying tucks
203199	13355	" " " " narrow tucks
203200	13355	" " " " tucks toward the needle
225873	10363	Space Gauge
200460B	10365	" " Adjusting Thumb Screw
225874	10363	" " Base Plate with 225983 and two 200843E
225876	10365	Space Gauge Index Plate
225983	10365	" " " " Pin
225877	10365	" " Stop (back), for cluster tucking
200843E	10365	Space Gauge Stop Screw Stud
201562B	10365	" " " " " "
		Thumb Nut
202603	10346	Space Gauge Stop Screw Stud Thumb Nut Washer
225878	10365	Space Gauge Stop (front), for cluster tucking
225879	—	Space Gauge complete, Nos. 200460B, 225873, 225874, 225876 to 225878, two each 201562B and 202603

No.	Plate	Name
225880	10363	Swivel
200727C	10364	" Adjusting Stop Screw
201517D	10364	" " " " Nut ...
225867	10363	" Base with three wood screws $1\frac{1}{2}$ in., No. 13
200753E	10364	Swivel Screw Stud
201651H	10364	" " " Nut
225881	10365	" " " Spring (spiral)
225882	10364	" " " " Washer
226256	—	Attachment Holding Swivel complete, Nos. 200224H, 200753E, 201651H, 225867, 225876, 225880 to 225882, 225884 to 225888, two each 200043C, 200048B, 200093B, 200727C, 201517D and 225023
202827	10390	Throat Plate, 53 needle hole, for neele sizes 12 and 13, with 202534, 202619 and two 200583H
225883	10363	Tuck Guide
225884	10363	" " Arm
225885	10363	" " " Bracket
225023	10364	" " " " Center
200043C	10246	" " " " Set Screw..
225886	10364	" " " " Spring (plate)
225887	10364	" " " " " Position Pin
225888	10364	Tuck Guide Arm Bracket Spring (spiral)
200224H	10248	Tuck Guide Arm Bracket Spring Screw
200727C	10364	Tuck Guide Arm Bracket Stop Thumb Screw
201517D	10364	Tuck Guide Arm Bracket Stop Thumb Screw Nut
225876	10365	Tuck Guide Arm Index Plate
200093B	10365	" " " " " Adjusting Screw
200048B	10365	Tuck Guide Arm Screw
225900	—	Tuck Guide and Swivel complete, Nos. 225883 and 226256
226235	—	Tucker (long Arm) complete, Nos. 225879 and 225900
225979	—	Adjustable Bench Tuck Folder complete, Nos. 202293, 202827, 203198 to 203200 and 226235

From the library of: Diamond Needle Corp

TUCK FOLDER

For Small Pieces of Goods

No.	Plate	Name
225923	10321	Folder
200090c	11598	" Adjusting Screw
225924	10321	" Arm
200836E	11598	" Screw Stud
200318H	11598	" " " Adjusting Screw
206840	11598	" " " " " "
		Spring Washer
201564B	11598	Folder Screw Stud Thumb Nut
202600	11598	" " " " " "
		Washer
203198	13355	Presser Foot, for laying tucks
203199	13355	" " " " narrow tucks
203200	13355	" " " " tucks toward
		the needle
225926	10321	Space Gauge
200843E	10365	" " Stop Screw Stud
201562B	10365	" " " " " "
		Thumb Nut
202603	10346	Space Gauge Stop Screw Stud
		Thumb Nut Washer
225927	10321	Tuck Folder complete, Nos.
		200090c, 200318H, 200836E, 200843E,
		201562B, 201564B, 202600, 202603,
		206840, 225923, 225924 and 225926

HEMMERS

HEMMER FEET

No.	Plate	Name
225800	10354	Hemmer Foot, for lace, for $\frac{1}{16}$ in. hem
225502	10354	Hemmer Foot, for $\frac{1}{16}$ in. hem
225805	10354	" " " lace, for $\frac{1}{8}$ in. hem
225504	10354	Hemmer Foot, for $\frac{1}{8}$ in. hem
206974	11600	" " " $\frac{1}{8}$ in. hem
225806	10354	" " " $\frac{3}{16}$ in. hem
225503	10354	" " " lace, for $\frac{3}{16}$ in. hem
225801	10393	Hemmer Foot, for $\frac{1}{4}$ in. hem, for thick soft woolens and felling corset seams
225740	10393	Hemmer Foot, for $\frac{1}{2}$ in. hem
225802	10393	" " " $\frac{3}{8}$ and $\frac{1}{2}$ in. hem, for cord guiding, sews a cord within the hem
229843	11600	Hemmer Foot, for $\frac{3}{8}$ and $\frac{1}{2}$ in. hem, for cord guiding, sews a cord within the hem
229843	11600	Hemmer Foot, for $\frac{3}{8}$ and $\frac{1}{2}$ in. hem, for cord guiding, sews a cord within the hem

Note: Specify width wanted on order.

PRESSER FOOT CLEFT HOLDERS

206842	13356	Presser Foot Cleft Holder
225865	10355	" " " " for use with 206998, for interchangeable Pressers and Hemmers

HEMMERS

225807	10355	Hemmer, for $\frac{1}{16}$ in. hem
225808	10355	" " $\frac{1}{8}$ in. hem, for felling
225809	10355	" " $\frac{1}{8}$ in. hem
225810	10355	" " $\frac{3}{16}$ in. hem
225811	10355	" " $\frac{3}{16}$ in. hem
225812	10355	" " $\frac{3}{16}$ in. hem, for "L" shaped Feed Dog 202283 only ..
225813	10355	Hemmer, for $\frac{1}{4}$ in. hem (Troy, long)

No.	Plate	Name
225814	10355	Hemmer, for $\frac{1}{8}$ in. hem (Troy, short)
225815	10355	Hemmer, for $\frac{3}{16}$ in. hem
231168	10355	" " $\frac{1}{4}$ in. hem
225816	10355	" " $\frac{1}{2}$ in. hem
225817	10355	" " $\frac{3}{4}$ in. hem

HEMMERS ON SHANK

225803	10353	Hemmer on Shank, for hems of the following widths: $\frac{1}{8}$, $\frac{3}{16}$, $\frac{1}{4}$, $\frac{5}{16}$, $\frac{3}{8}$, $\frac{7}{16}$ and $\frac{1}{2}$ inch
		Note: Specify width wanted on order.
225804	10353	Hemmer on Shank, for hems of the following widths: $\frac{5}{8}$, $\frac{3}{4}$, $\frac{7}{8}$, $\frac{1}{2}$, $\frac{3}{4}$, $\frac{7}{8}$, $\frac{15}{16}$ and 1 inch
		Note: Specify width wanted on order.
225770	10345	Hemmer on Shank, for hems of the following widths: $1\frac{1}{8}$, $1\frac{1}{4}$, $1\frac{3}{8}$, $1\frac{1}{2}$, $1\frac{5}{8}$, $1\frac{3}{4}$ and $1\frac{7}{8}$ inches
		Note: Specify width wanted on order.
225771	10345	Hemmer Plate
225772	10345	" Shank Clamp Washer
200184D	10345	" " Screw
225773	10379	Hemmer complete, Nos. 225770 to 225772 and two 200184D
225957	10935	Hemmer on Shank, for hems of the following widths: 2, $2\frac{1}{4}$ and $2\frac{1}{2}$ inches
		Note: Specify width wanted on order.
225987	10379	Hemmer complete, Nos. 225771, 225772, 225957 and two 200184D
225958	10935	Hemmer on Shank, for hems of the following widths: $2\frac{5}{8}$, $2\frac{3}{4}$, $2\frac{7}{8}$ and 3 inches
		Note: Specify width wanted on order.
225988	10379	Hemmer complete, Nos. 225771, 225772, 225958 and two 200184D

HEMMER

For Sheets, Etc., Sizes from $\frac{1}{2}$ to $3\frac{1}{4}$ inches.

Note: Specify width wanted on order.

225794	—	Hemmer on Shank
200160B	11600	" Adjusting Screw
226663	11600	" " " Washer
203075	10935	" Base Plate with 225706

No.	Plate	Name
230000	11599	Hemmer Base Plate 203075 with 200246B, 201525E, 225708, 226663 and two 200160B
225706	10313	Hemmer Base Plate Position Pin
200246B	11600	" " " Screw
201525E	10245	" " " " Nut
225708	10344	" " " Spring
225796	10321	Hemmer complete, for hems $\frac{1}{2}$ to $3\frac{1}{4}$ in., Nos. 225794 and 230000

HEMMER

For Hemming Pillow Cases or Other Tubular Work.

For Hems from $\frac{1}{2}$ to 4 inches

Note: Specify width wanted on order.

203075	10935	Base Plate with 225706
230000	11599	" " 203075 with 200246B, 201525E, 225708B, 226663 and two 200160B
225706	10313	Base Plate Position Pin
200246B	11600	" " Screw
201525E	10246	" " " Nut
225708	10344	" " Spring
*225764	10935	Hemmer on Shank
*225767	10935	" Plate with 200857E and 225586
226663	11600	Hemmer Plate Clamp Washer
200160B	11600	" " " " Screw
225586	11600	" Shank Position Pin
200857E	11600	" " Screw Stud
225765	10344	" " Switch Handle with 200385C and 201609
*201609	—	Hemmer Shank Switch Handle Stud
200385C	10344	Hemmer Shank Switch Handle Stud Set Screw
204004	11600	Hemmer Shank Switch Handle Washer
225769	10321	Hemmer complete, for hems $\frac{1}{2}$ to 4 in., Nos. 204004, 225764, 225765, 225767 and 230000

HEMMER ON SWING BRACKET

225970	11600	Hemmer on Shank, for hems of the following widths: $\frac{1}{8}$, $\frac{3}{16}$, $\frac{1}{4}$, $\frac{5}{16}$, $\frac{3}{8}$, $\frac{7}{16}$ and $\frac{1}{2}$ inch
		Note: Specify width wanted on order.

No.	Plate	Name
226110	11599	Hemmer Swing Bracket with 200369D and 200862E
226977	—	Hemmer Swing Bracket 226110 with 200157D, 201526E, 201563B, 225734, 225735 and 226071
200369D	11600	Hemmer Swing Bracket Adjusting Screw
225735	10335	Hemmer Swing Bracket Base
200157D	13353	" " " " Hinge Screw
201526E	10335	Hemmer Swing Bracket Base Hinge Screw Nut
226071	10335	Hemmer Swing Bracket Base Hinge Screw Spring Washer ..
200862E	11600	Hemmer Swing Bracket Base Screw Stud
201563B	10335	Hemmer Swing Bracket Base Screw Stud Thumb Nut
225734	10335	Hemmer Swing Bracket Base Screw Stud Washer
225973	—	Hemmer on Swing Bracket complete, Nos. 225970 and 226977 ..

REVERSE HEMMER

For Turning the Hem Under

225776	10346	Hemmer, for $\frac{3}{8}$ in. hem
225777	10346	" Shank
200142B	10346	" Screw
202603	10346	" " " Washer
225778	10346	Hemmer complete, Nos. 200142B, 202603, 225776 and 225777

REVERSE HEMMER

For Hemming and Stitching on Lace

225779	10347	Hemmer on Shank, for $\frac{3}{8}$ in. hem
225780	10347	" Lace Guide
200142B	10346	" Shank Screw
202603	10346	" " " Washer
225781	10347	Hemmer (reverse) complete, Nos. 225779, 225780, two each 200142B and 202603

HEMMER

For Hemming Tubular Articles with Movable Folder for Finishing Off. State Gauge Required

Made for hems from $\frac{1}{2}$ to $1\frac{1}{2}$ in., in steps of $\frac{1}{16}$ inch

No.	Plate	Name
203075	10935	Base Plate with 225706
230000	11599	" " 203075 with 200246B, 201525E, 225708, 226663 and two 200160B
225706	10313	Base Plate Position Pin
200246B	11600	" " Screw
201525E	10245	" " " Nut
225708	10344	" " Spring
225787	11599	Hemmer on Shank
200460B	10365	" Adjusting Thumb Screw
228043	11600	" " " Washer
230864	11599	Hemmer Plate
226663	11600	" " Clamp Washer ..
200160B	11600	" " " " Screw
230865		Hemmer complete, Nos. 200460B, 225787, 228043, 230000 and 230864

HEMMER

For Hemming Tubular Articles with Movable Folder for Finishing Off. State Gauge Required

Made for hems from $\frac{1}{4}$ to 1 in., in steps of $\frac{1}{16}$ inch

225790	10350	Hemmer on Shank
225791	10350	" Base Plate with 200838E ..
200838E	10350	" " " Screw Stud
201557B	10350	" " " " " Nut ..
225792	10350	Presser Foot
225793	10350	Hemmer complete, Nos. 201557B and 225790 to 225792

PLAITER

FOLDS TUCK PLAITS

No.	Plate	Name
225827	10357	Base Plate
225828	10357	" " Arm Bracket with two 200383c
225829	10358	Base Plate Arm Shaft
200383c	10246	" " " " Set Screw
200579E	10359	" " Set Screw
225830	10258	Folder Guide
200110B	10359	" " Set Screw
225831	10358	" Bracket
225919	-----	" " 225831 with 225830, 225833, two each 200110B and 200137c
225909	10358	Folder Bracket Guide Stop with 200382c
200382c	10359	Folder Bracket Guide Stop Set Screw
226164	10359	Folder Bracket Stop Collar with 200113F
200113F	10359	Folder Bracket Stop Collar Set Screw
225833	10358	Folder Bracket Stop Spring
200137c	10359	" " " " Screw
225835	10358	Guide
225836	10358	" Adjustable Stop
200169B	10359	" " " Screw
200845B	10359	" Screw Stud
200651B	10359	" " " Handle Screw ..
226163	10359	" " " Washer
225839	10358	Space Guide
225840	10358	" " Bracket
200417A	10359	" " " Position Screw
201532E	10359	" " " " "
		Nut
226164	10359	Space Guide Bracket Stop Collar with 200113F
200113F	10359	Space Guide Bracket Stop Collar Set Screw
200462B	10245	Space Guide Bracket Thumb Screw
200110B	10359	" " Set Screw

No.	Plate	Name
225841	-----	Space Guide complete, Nos. 200417A, 200462B, 201532E, 225839, 225840 and two 200110B
225842	10321	Plaiter complete, Nos. 200169B, 200651B, 200845B, 225827 to 225829, 225835, 225836, 225841, 225909, 225919, 226163, two 226164 and three 200579E

RUFFLER

With Separating Blade and Disengaging Lever to Switch
the Ruffling Blade Out of or In to Action for Inter-
mittent Ruffling Such as Yoking Shirts, Etc.

No.	Plate	Name
225843	10360	Driving Lever
200255D	10360	" " Hinge Screw
225844	10360	" " Spring
201554D	10360	" " " Adjusting Nut
225845	10360	Frame with 225959
225846	10361	Guide (left) with 225856 and two 200178D
225847	10361	Guide (right) with 225856 and two 200178D
Note: Nos. 225846 and 225847 are sent only on order.		
200126D	10361	Guide Screw
225848	10360	Needle Bar Collar (for driving 225843)
201856	11600	Needle Bar Collar Roller
200615C	10360	" " " " Screw ..
225850	10360	Needle Bar Collar complete, Nos. 200615C, 201856 and 225848
225851	10360	Ruffling Blade
225852	10360	" " Clamp
200175R	10360	" " " Screw
225853	10360	" " Lever with 225852, 225854 and two 200175R
200465F	10360	Ruffling Blade Lever Adjusting Thumb Screw
225854	10360	Ruffling Blade Lever Adjusting Thumb Screw Bushing
201583C	10360	Ruffling Blade Lever Adjusting Thumb Screw Wing Nut
225855	10360	Ruffling Blade Switching Lever
200310C	10360	" " " " " Hinge Screw
225959	10360	Ruffling Blade Switching Lever Stop Pin
225856	10361	Separating Blade
200178D	10361	" " Screw
225857	10361	Ruffler complete, Nos. 200126D, 200255D, 200310C, 200465F, 201554D, 201583C, 225843 to 225845, 225850, 225851, 225853 and 225855

IRON BASE

FOR MACHINE No. 61w34 WHEN USING BENCH
TUCK FOLDER

No.	Plate	Name
227338	-	Bed Frame with four 227731 and four wood screws 1 in., No. 13
227731	-	Bed Frame Cushion (leather)
225590	-	" " Plate Spring
200157B	13353	" " " " Screw
225591	-	" " Stop Chain with two 225592
225592	-	Bed Frame Stop Chain Hook
200724C	11600	" " Wing Screw
228165	-	Drip Pan
225593	-	Bed Frame (iron) complete, Nos. 200724C, 225590, 225591, 227338 and two 200157B
227256	-	Drip Pan
227089	-	Bed Frame (iron) complete, Nos. 200724C, 225591 and 227338

WOOD BASE

FOR MACHINE No. 61w34 WHEN USING BENCH
TUCK FOLDER

225968	10307	Bench Stand Section (back) with 225491, 225872, two each 225870, 227493 and three wood screws 2½ in., No. 16
225984	10307	Bench Stand Section (front) with two 225870 and two wood screws 2½ in., No. 16
228170	-	Drip Pan
225870	-	Machine Cushion (felt)
227493	12153	" Hinge Plate 202259 with two wood screws ¾ in., No. 13R
225491	11599	Machine Rest Pin (wood), 2¾ in. long
225872	11599	Machine Spring with three round head wood screws 1¼ in., No. 10
202730	11599	Rock Lever Rod, 8 in. long, with 202456
*202456	-	Rock Lever Rod Cap or Oil Guard
225895	-	Bench Stand (sectional, wood) complete, Nos. 225968 and 225984

RIBBON REELS

No.	Plate	Name
226200	-----	Ribbon Reel (6 in. diam.) with 225666 and three 205520
226211	-----	Ribbon Reel (holding projection, 6 3/4 in. diam.) with 226212 and 226213
225663	10321	Ribbon Reel (9 in. diam.) with 225666 and three 205520
226212	10911	Ribbon Reel Center Pin
226213	10911	" " " " Washer
225664	11598	" " Supporting Spindle
225665	10320	" " " " Base with 225664 and two wood screws 3/4 in., No. 7
230471	-----	Ribbon Reel Supporting Spindle Hub
225666	-----	Ribbon Reel Supporting Spindle Hub 230471 with 225980
225980	-----	Ribbon Reel Supporting Spindle Hub Base
205520	11598	Ribbon Reel Supporting Spindle Hub Base Rivet
226201	-----	Ribbon Reel (6 in. diam.) complete, Nos. 225665 and 226200
225976	-----	Ribbon Reel (9 in. diam.) complete, Nos. 225663 and 225665

OBSOLETE PARTS

No.	Plate	Name
*202967	----	Bobbin Case
202267	11671	" " Latch
*202056	----	" " " Pin
202269	11671	" " " Plunger
202270	11671	" " " Spring
202716	11671	" " Tension Spring
202796	10273	Bobbin Case complete, Nos. 200594c, 200984c, 202056, 202267, 202269, 202270, 202716 and 202967
202502	10273	Bobbin Case Lever Driving Cam with 200380c and 200444c
202503	10273	Bobbin Case Lever Driving Cam Lever with 200086c
202504	10273	Bobbin Case Lever Driving Cam Lever Spring (spiral)
206760	13363	Bobbin Case Lever Driving Eccentric Connection
206762	----	Bobbin Case Lever Driving Eccentric Connection 206760 with 206763
206759	13363	Bobbin Case Lever Driving Eccentric Connection Lever with 200086c and 206758
202841	10273	Bobbin Case Lever complete, Nos. 202500 to 202504
202505	-----	Bobbin Case Outfit complete, Nos. 200333c, 202796 and 202841
202470	10271	Bobbin Winder Base
202471	10271	" " Frame
202472	10271	" " " Spring
202474	10271	" " Spindle
202475	10271	" " Stop Latch
202477	10272	" " " Thumb Lever
202479	10271	Bobbin Winder complete, Nos. 200056e, 200161d, 200221n, 201537n, 202470 to 202475, 202477, 202478, three 200299n and two round head wood screws 1 in., No. 13..
202480	10271	Bobbin Winder Spool Holder Base with 200355n and 202484
202481	10271	Bobbin Winder Spool Holder Base Spool Pin

No.	Plate	Name
202482	10272	Bobbin Winder Spool Holder Tension Disc (lower or upper)
202483	10272	Bobbin Winder Spool Holder Tension Disc Spring (brass)
202484	10272	Bobbin Winder Spool Holder Tension Disc Thread Guide
202485	10271	Bobbin Winder Spool Holder complete. Nos. 200011E, 202480, 202481, 202483, two 202482 and one wood screw 1 in., No. 13
202064	13363	Hook Shaft Pin
206780	13353	" Washer

PLATE 10244—FULL SIZE

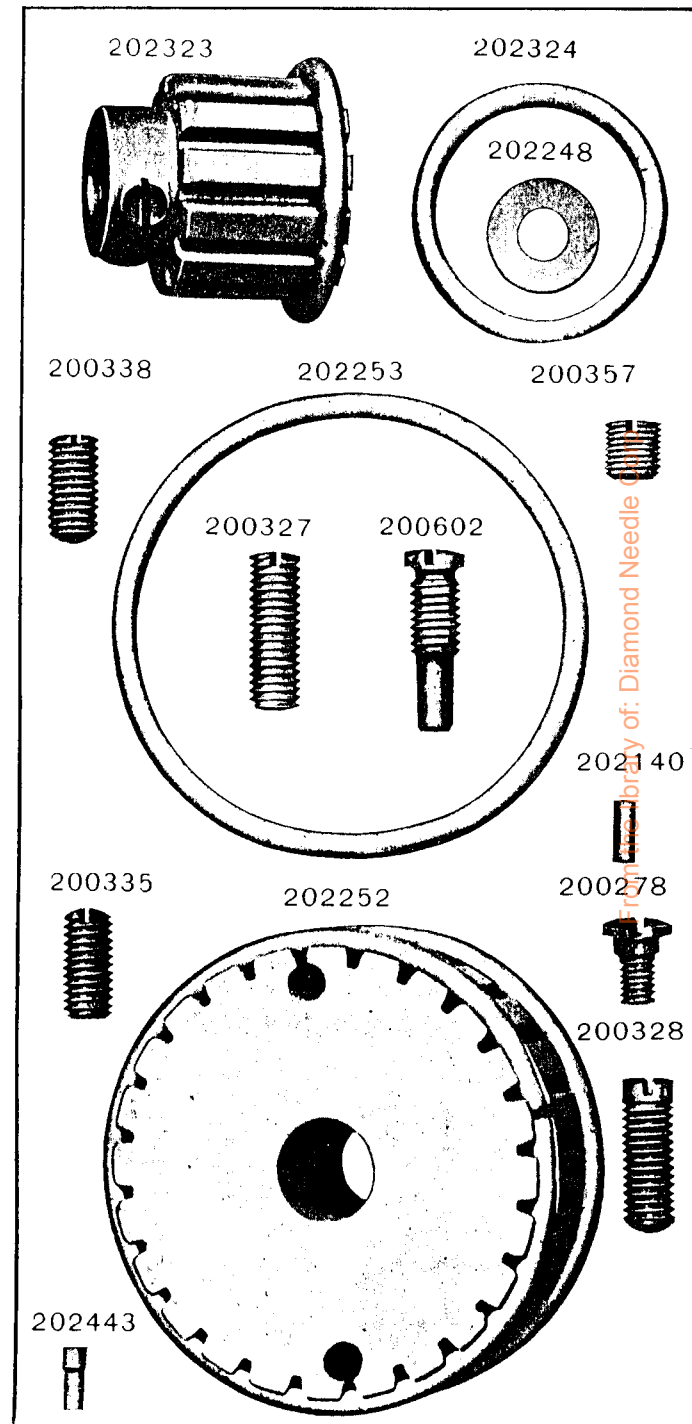


PLATE 10245—FULL SIZE

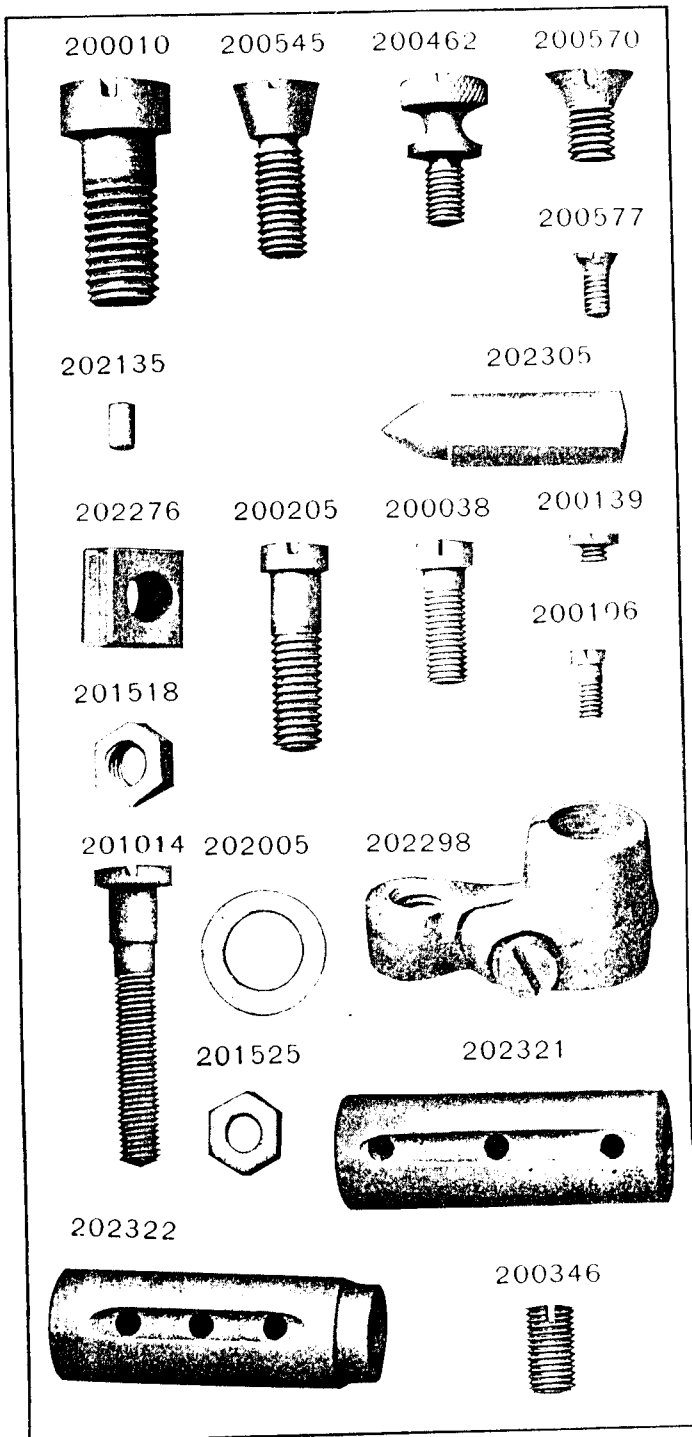
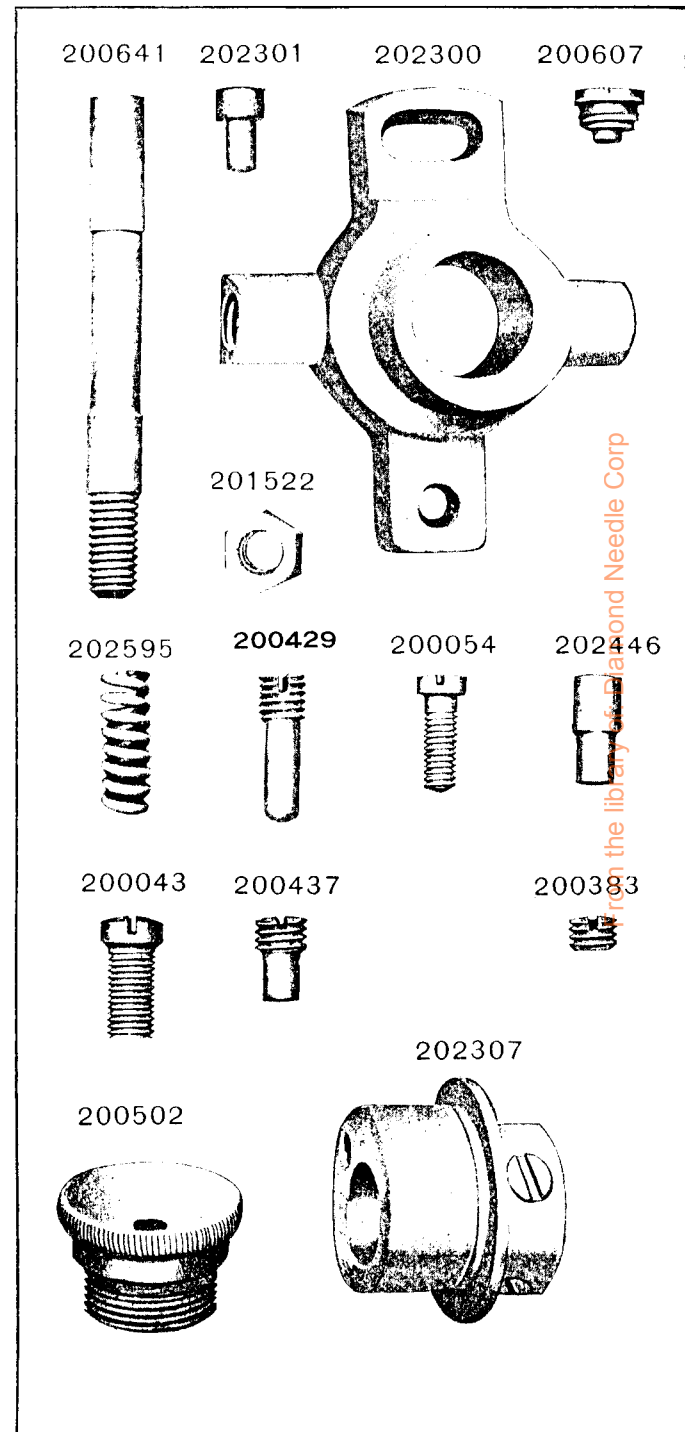


PLATE 10246—FULL SIZE



from the library of Diamond Needle Corp

PLATE 10247—FULL SIZE

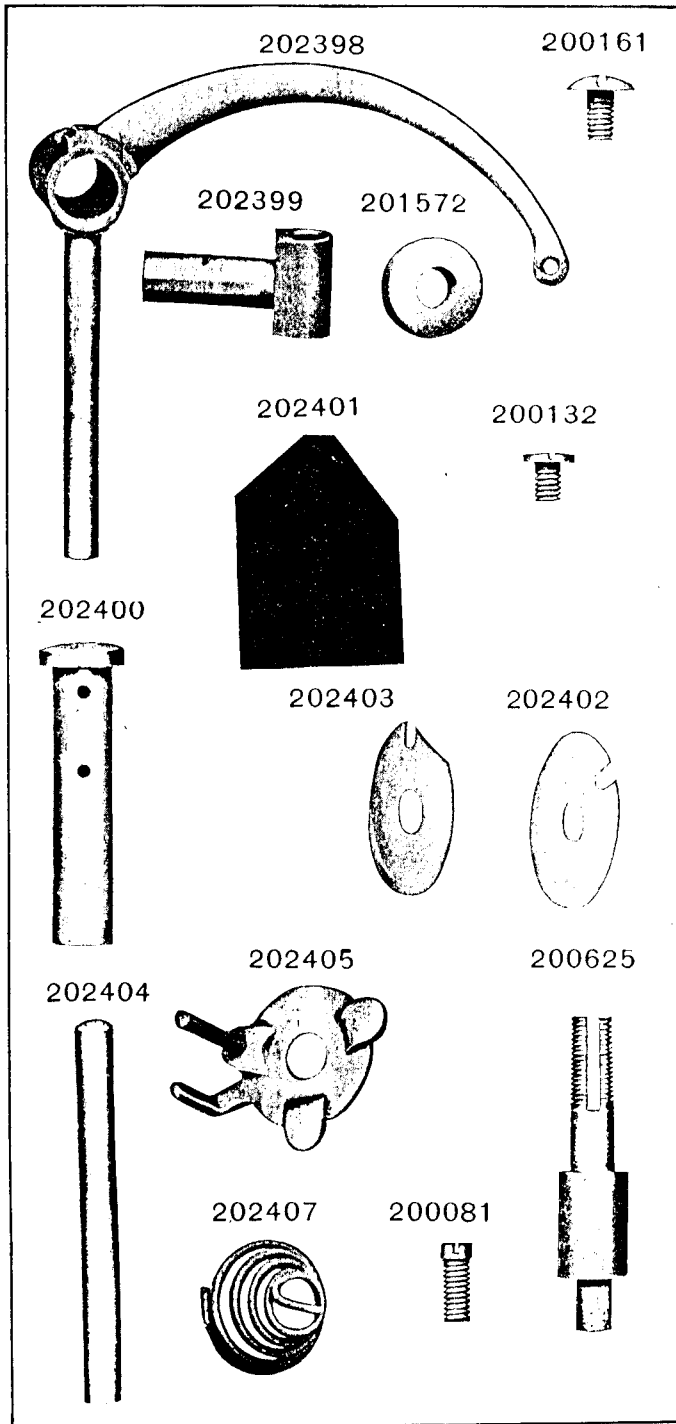


PLATE 10248—FULL SIZE

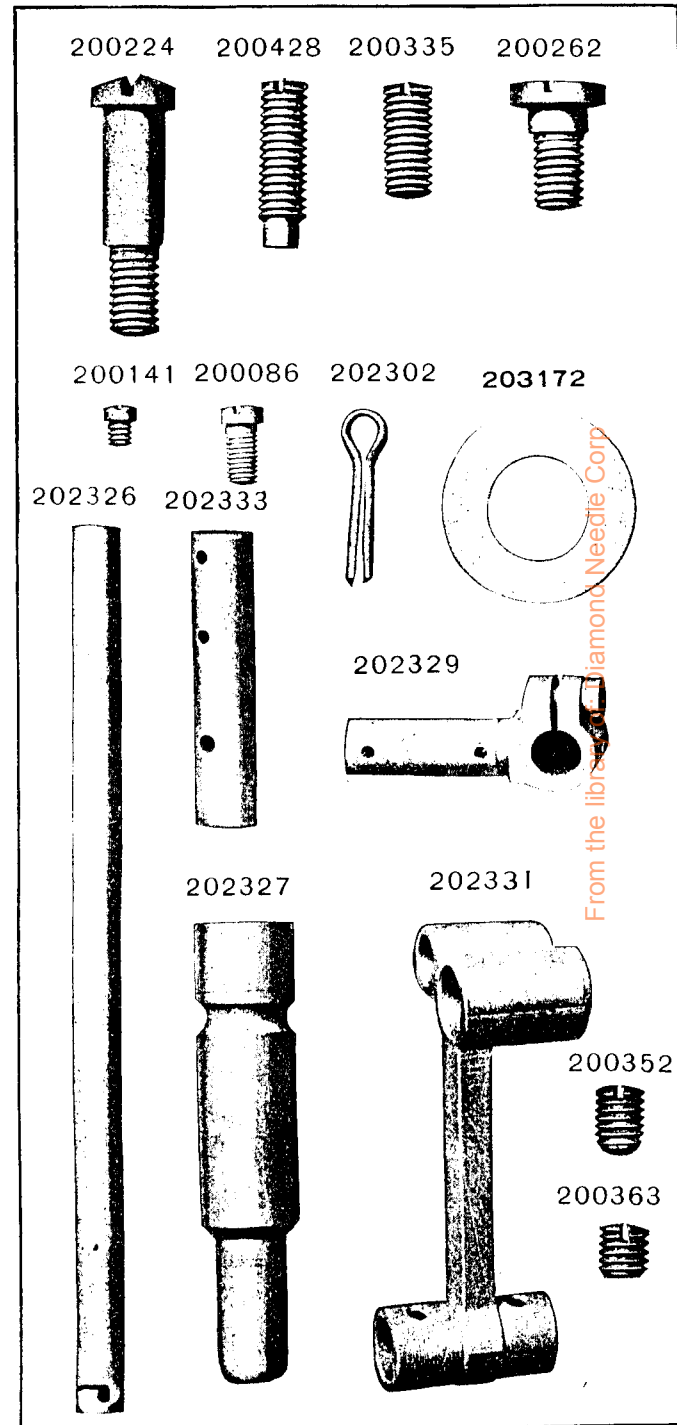


PLATE 10249—FULL SIZE

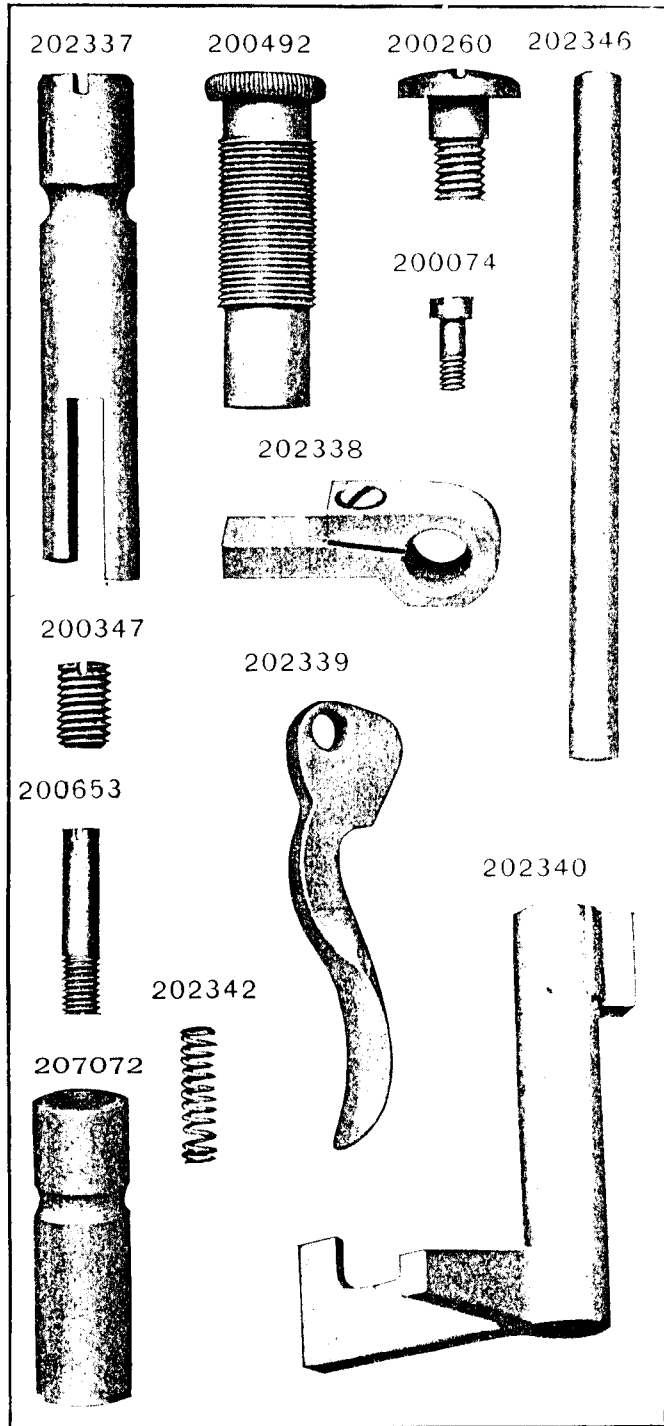


PLATE 10252—FULL SIZE

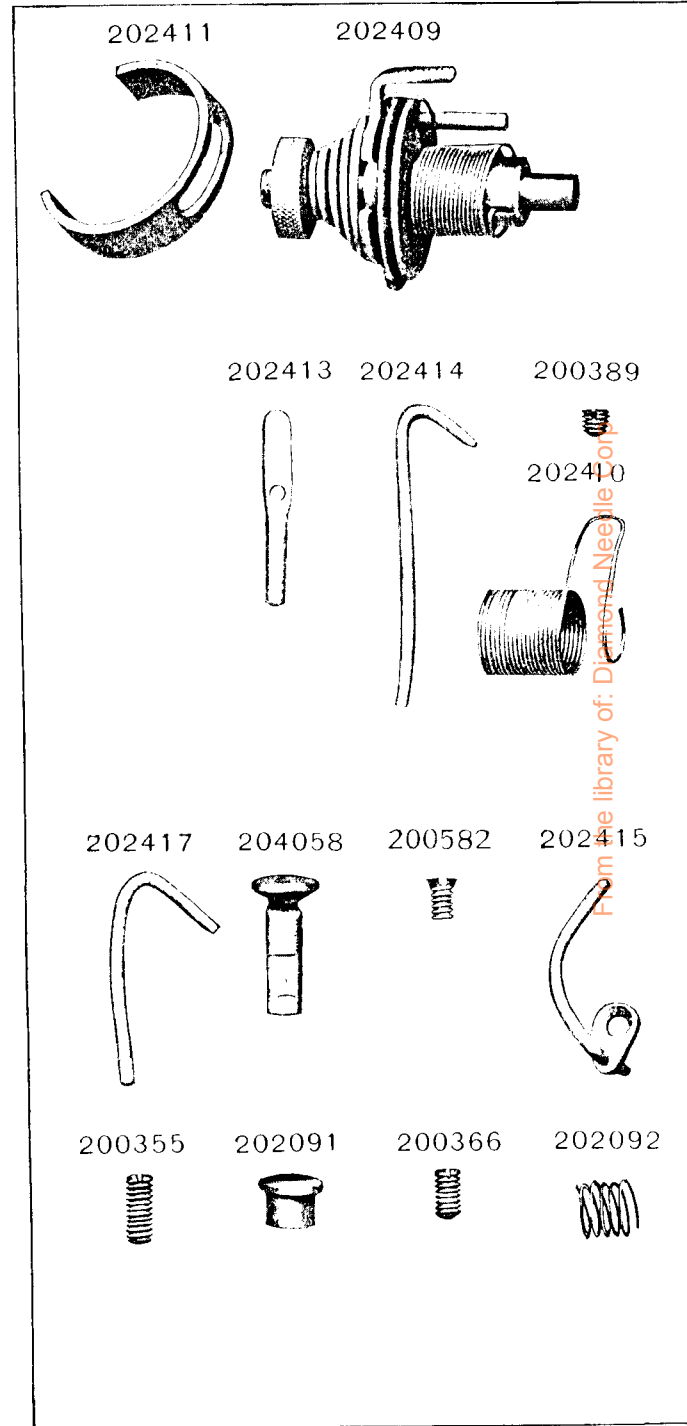
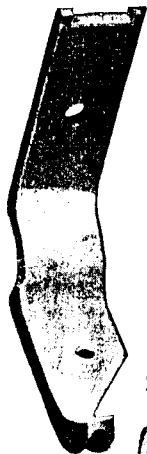


PLATE 10259-FULL SIZE

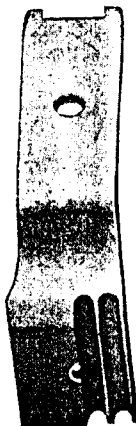
202368



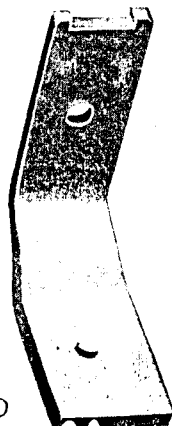
202368



202369



202369



202370



202370

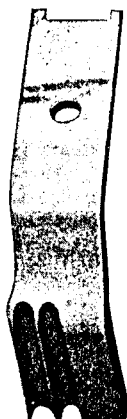


PLATE 10263-FULL SIZE

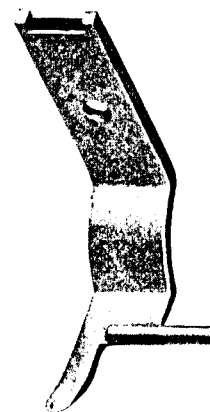
202390



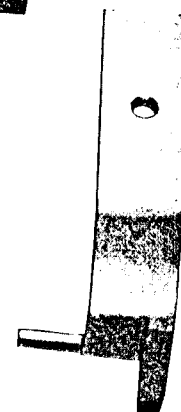
202390



202356



202356



From the library of: Diamond Needle Corp

PLATE 10271-ONE-HALF SIZE

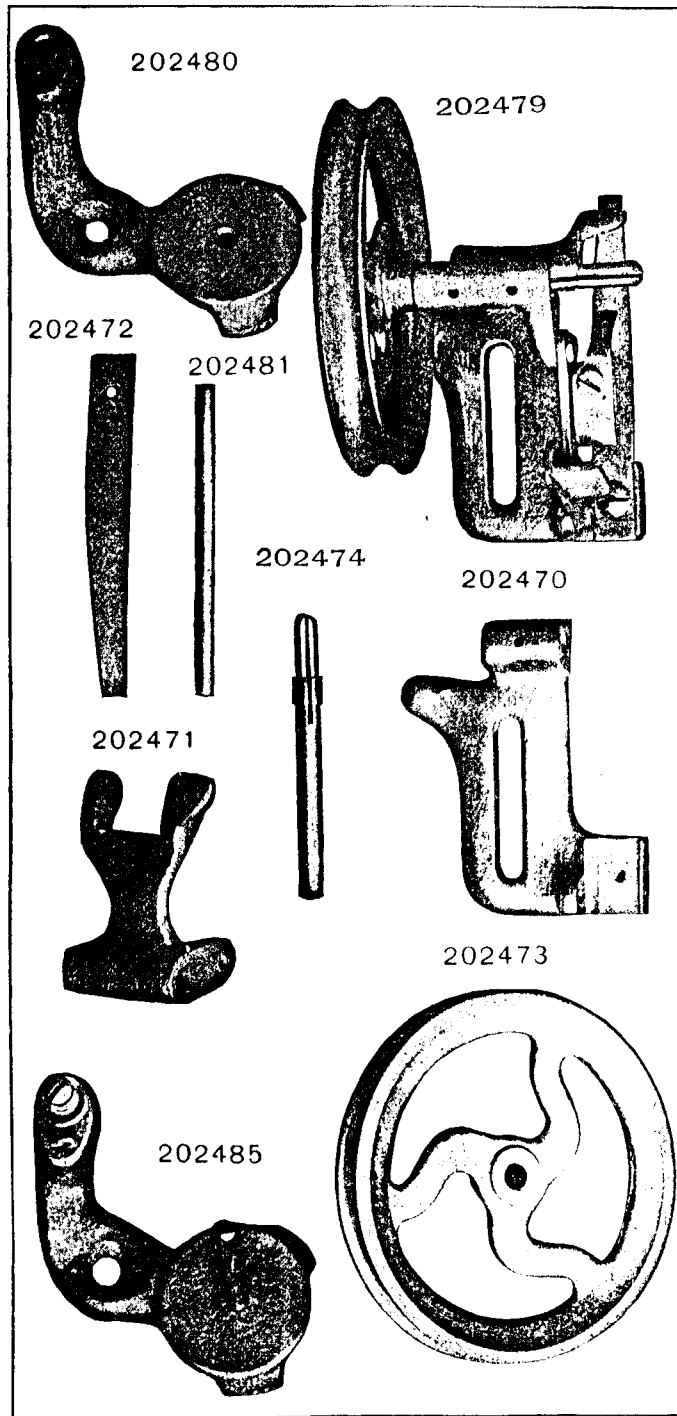
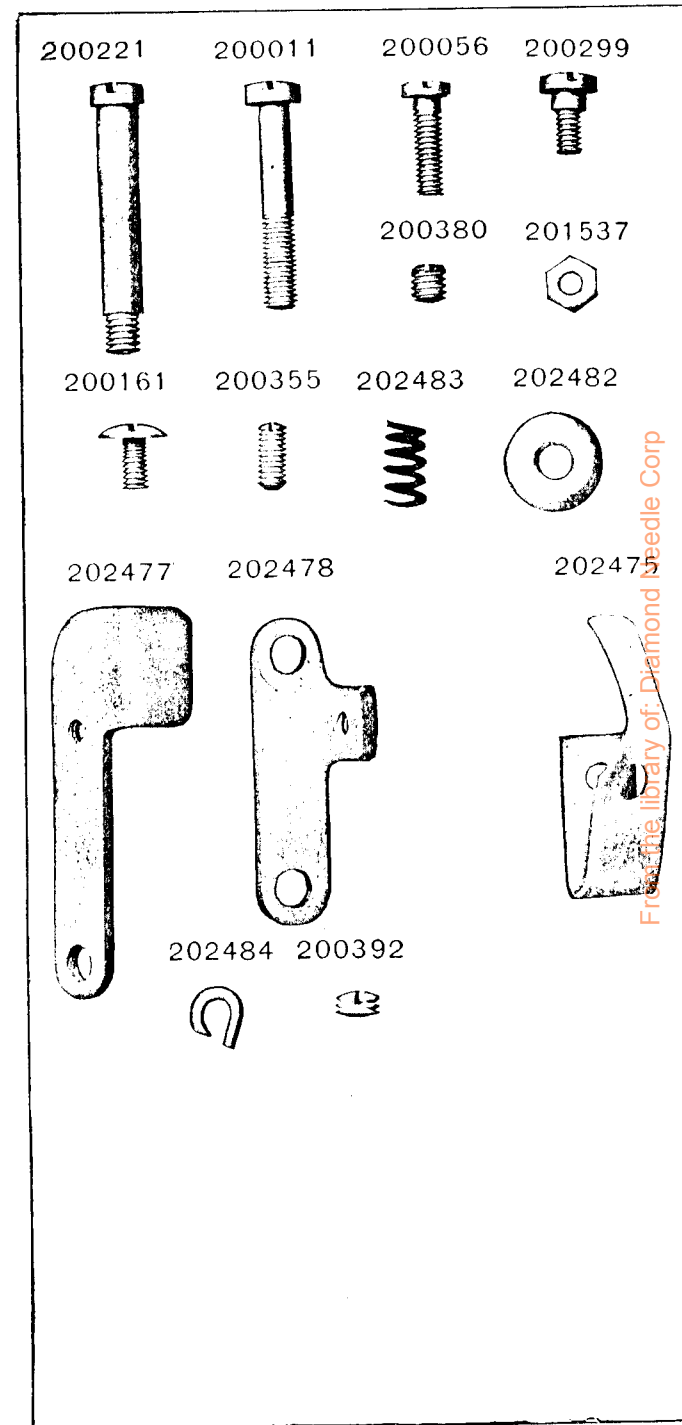


PLATE 10272-FULL SIZE



From the library of: Diamond Needle Corp

PLATE 10273—FULL SIZE

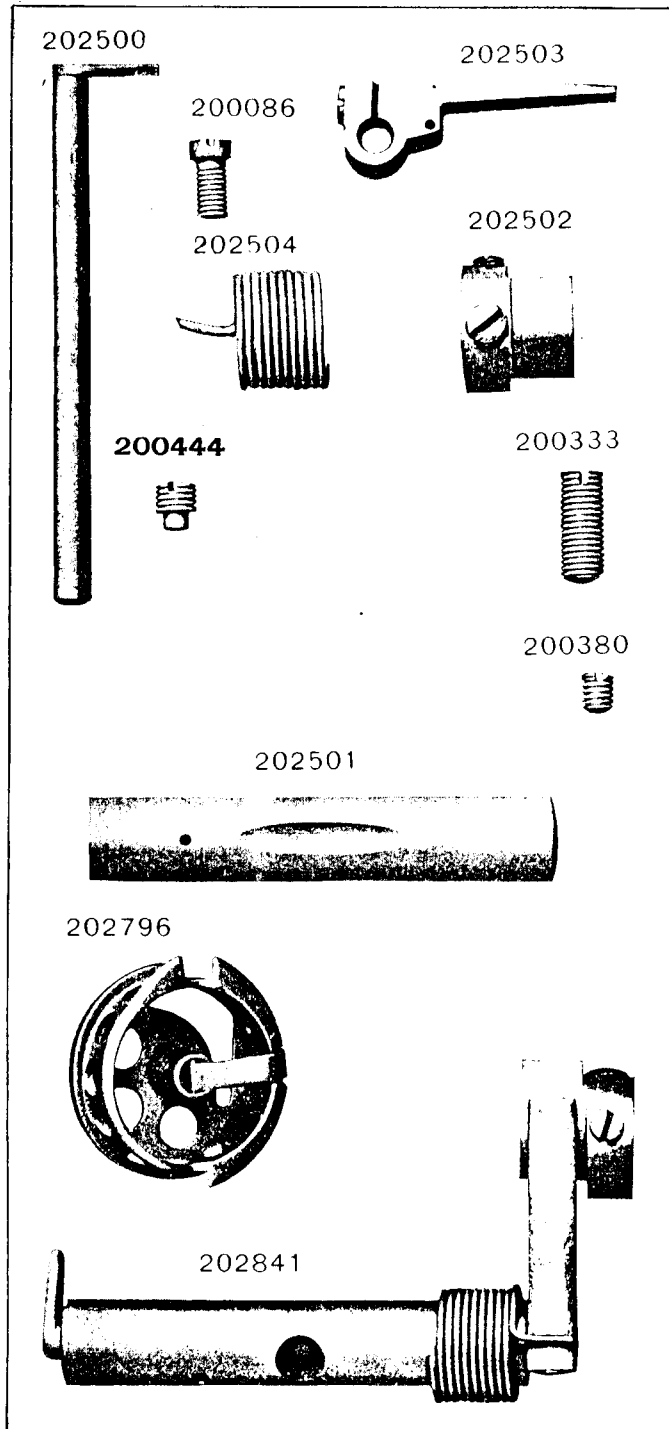
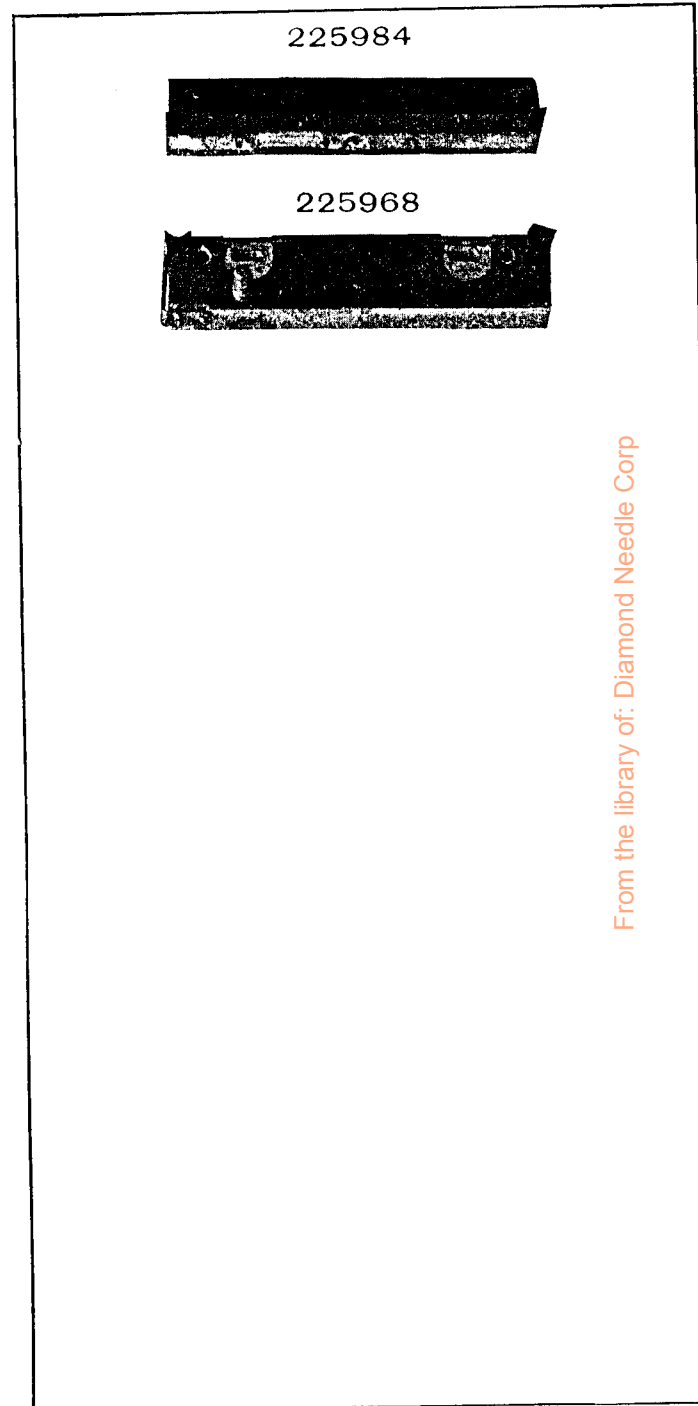


PLATE 10307—ONE-EIGHTH SIZE



From the library of: Diamond Needle Corp

PLATE 10309-FULL SIZE

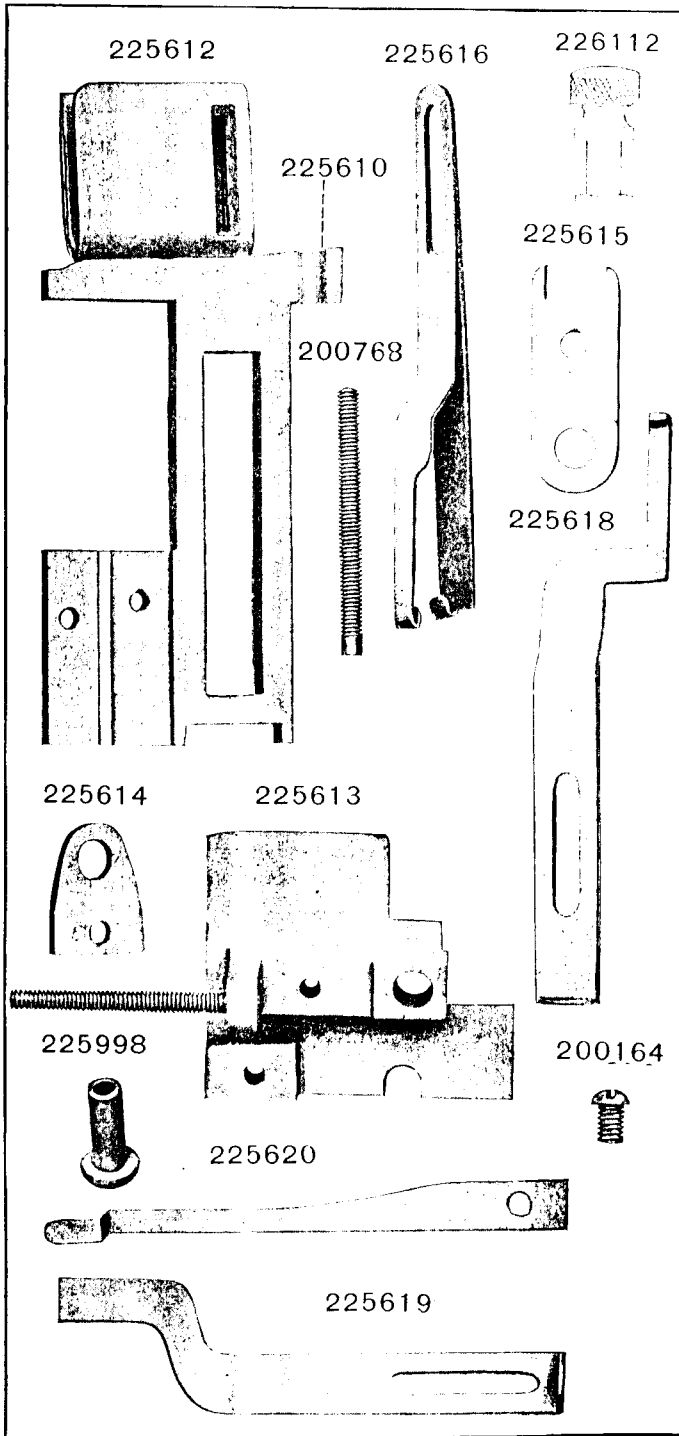
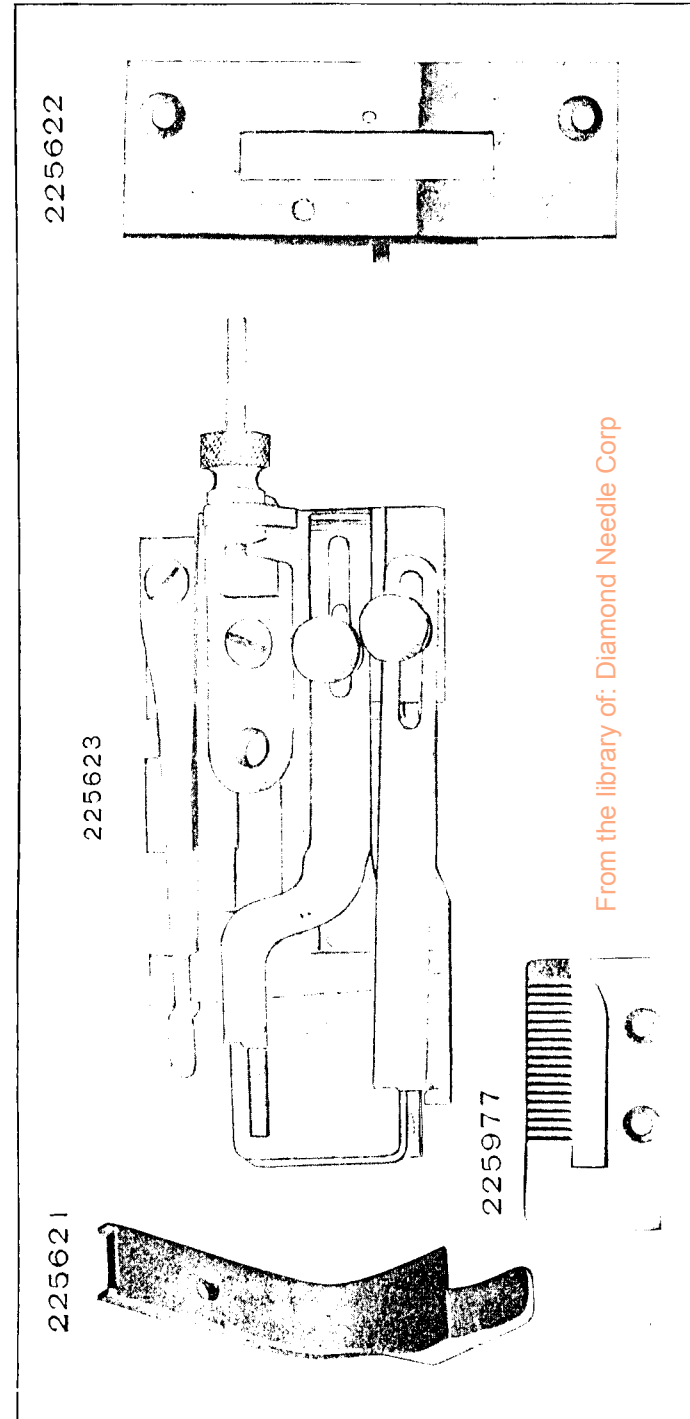


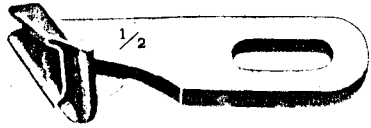
PLATE 10310-FULL SIZE



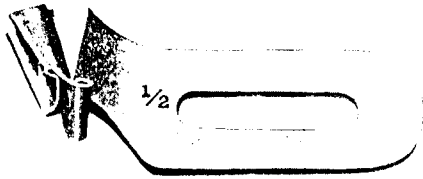
From the library of: Diamond Needle Corp

PLATE 10312—FULL SIZE

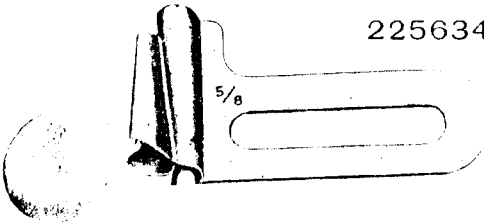
225630



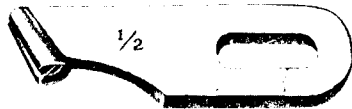
225631



225634



225633



202813

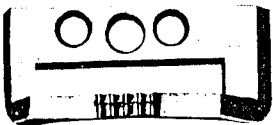


PLATE 10313—FULL SIZE

202104



200313



200462



201527



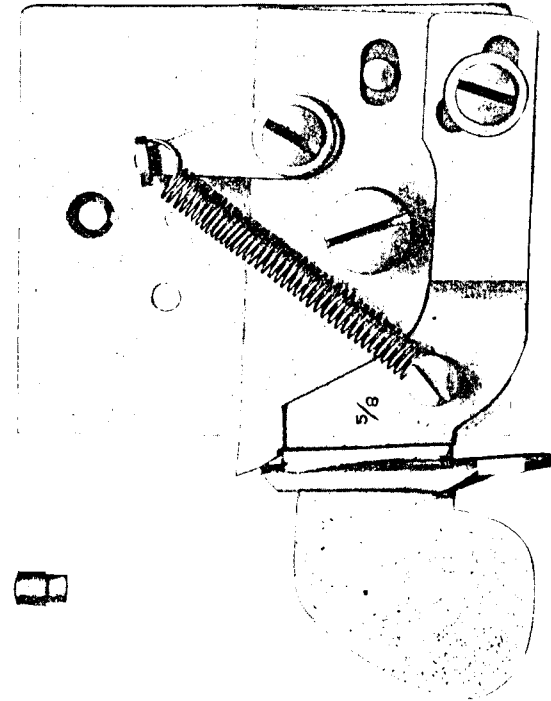
206053



200472



225645



225706



From the library of: Diamond Needle Corp

PLATE 10314-FULL SIZE

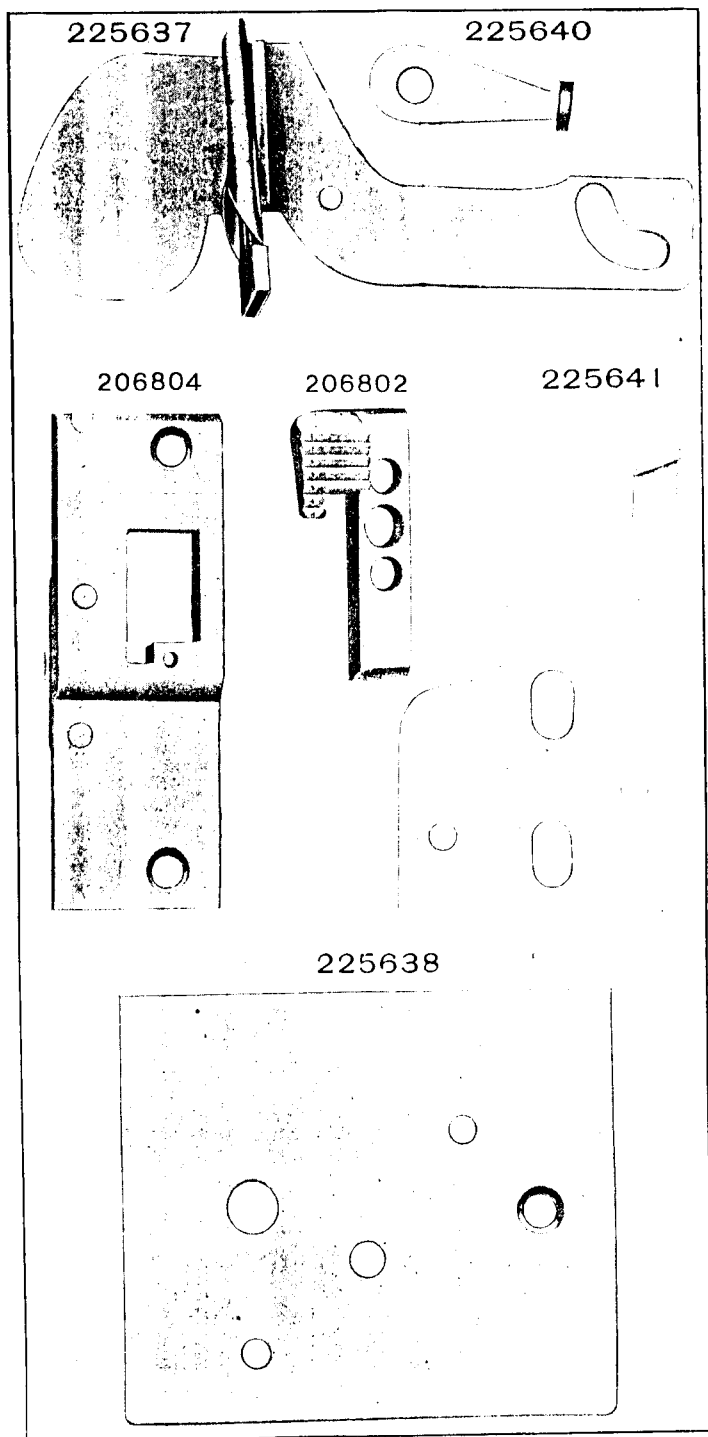


PLATE 10315-FULL SIZE

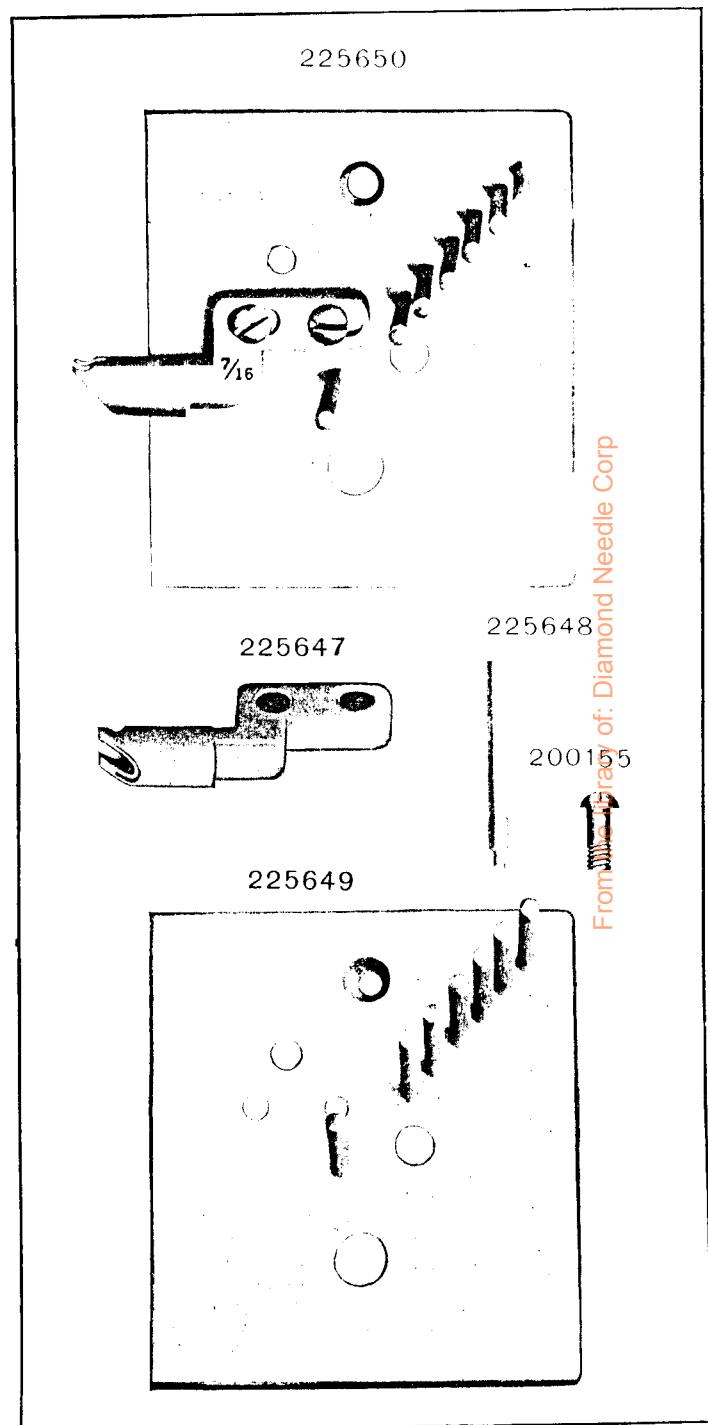


PLATE 10316—FULL SIZE

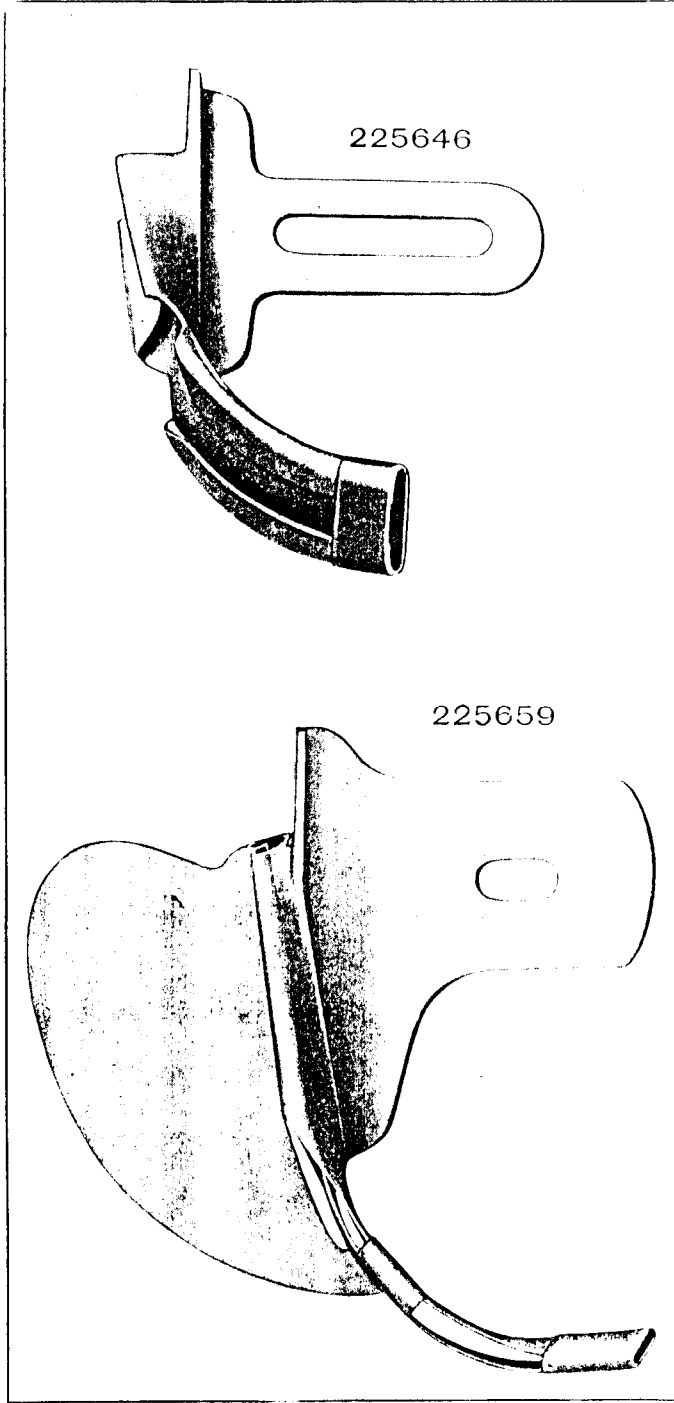


PLATE 10321—ONE-FOURTH SIZE

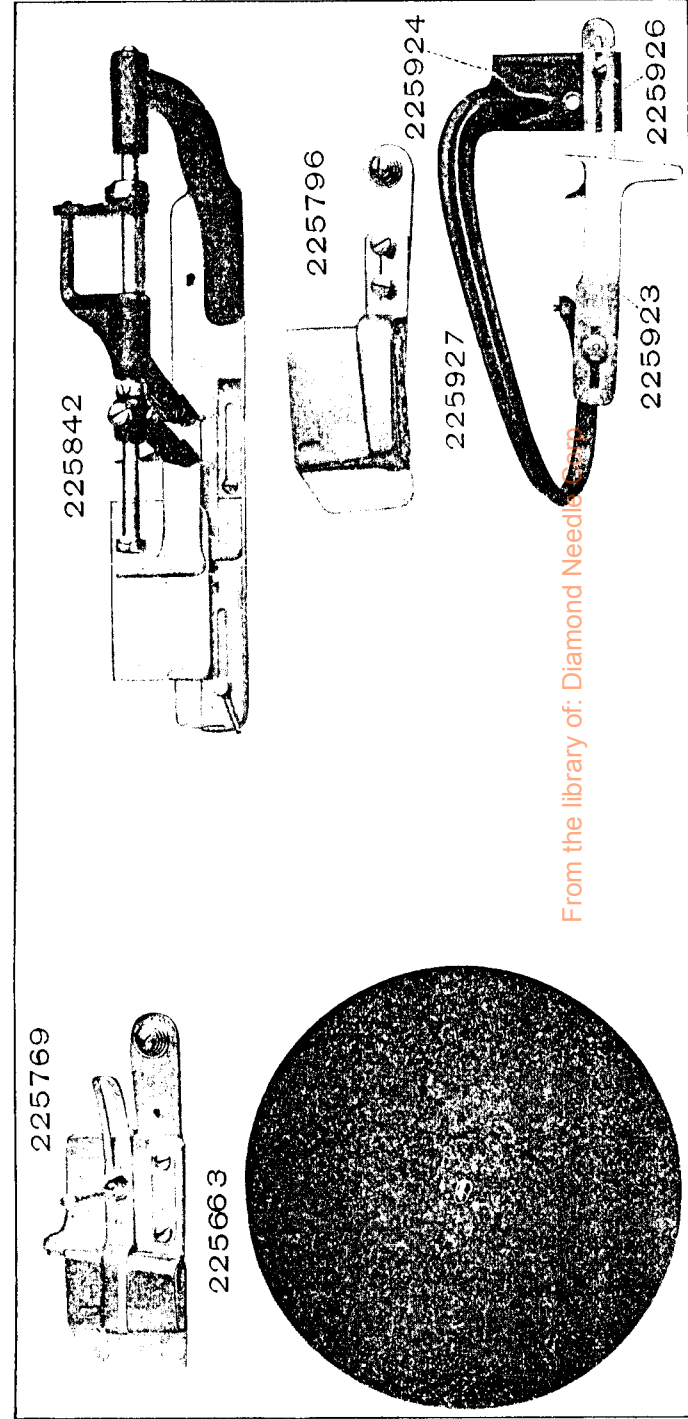


PLATE 10322—FULL SIZE

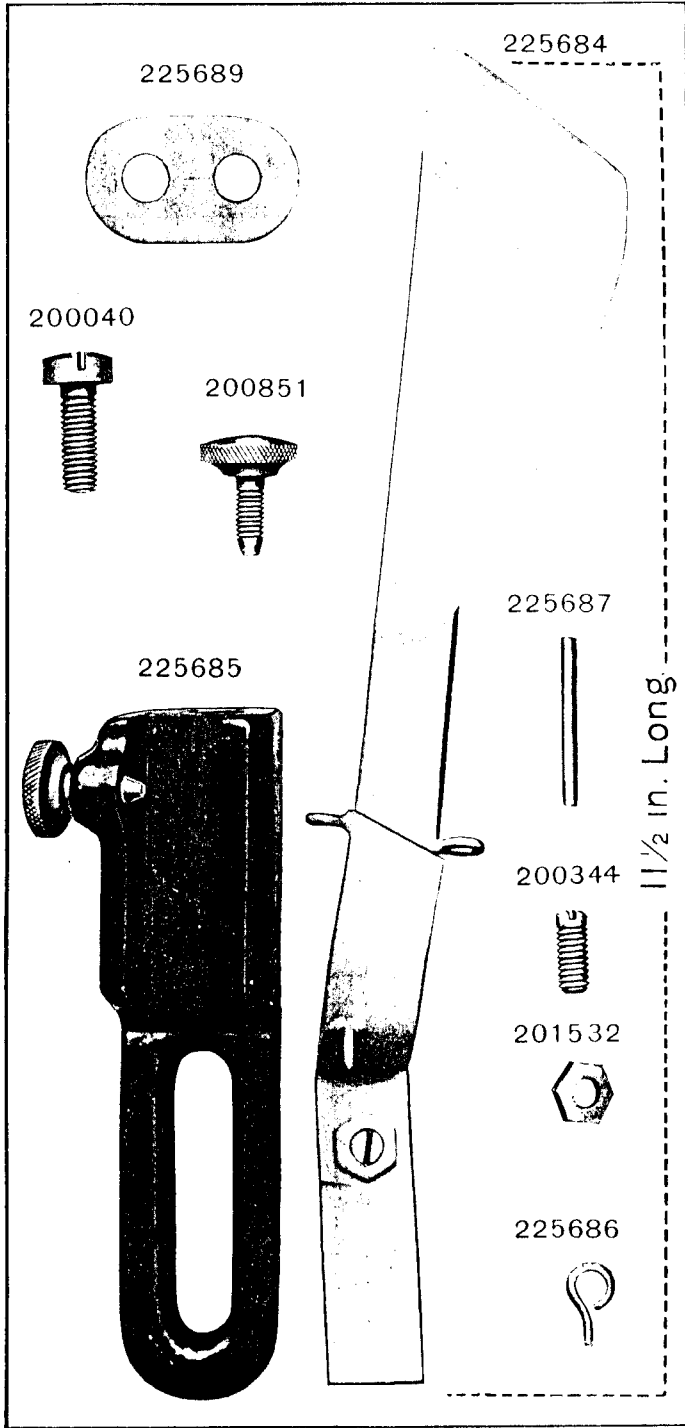


PLATE 10325—FULL SIZE

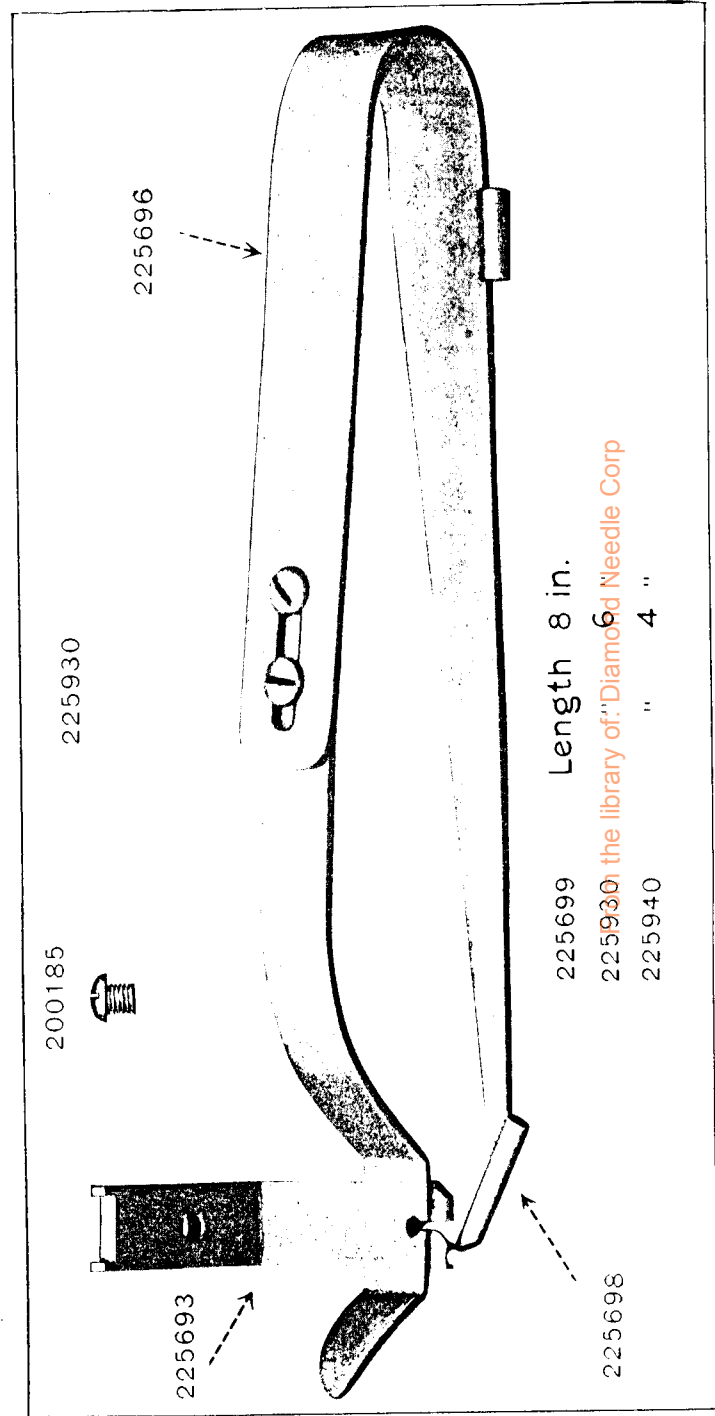


PLATE 10335—FULL SIZE

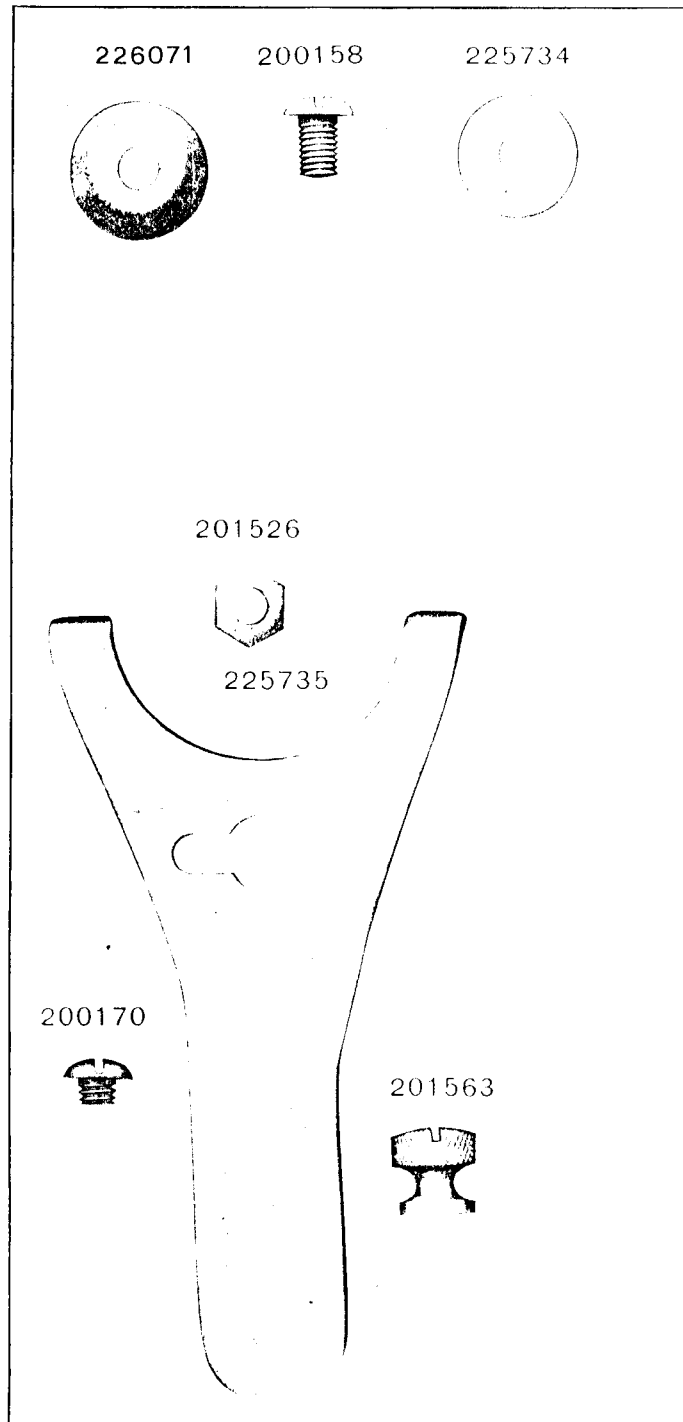


PLATE 10344—FULL SIZE

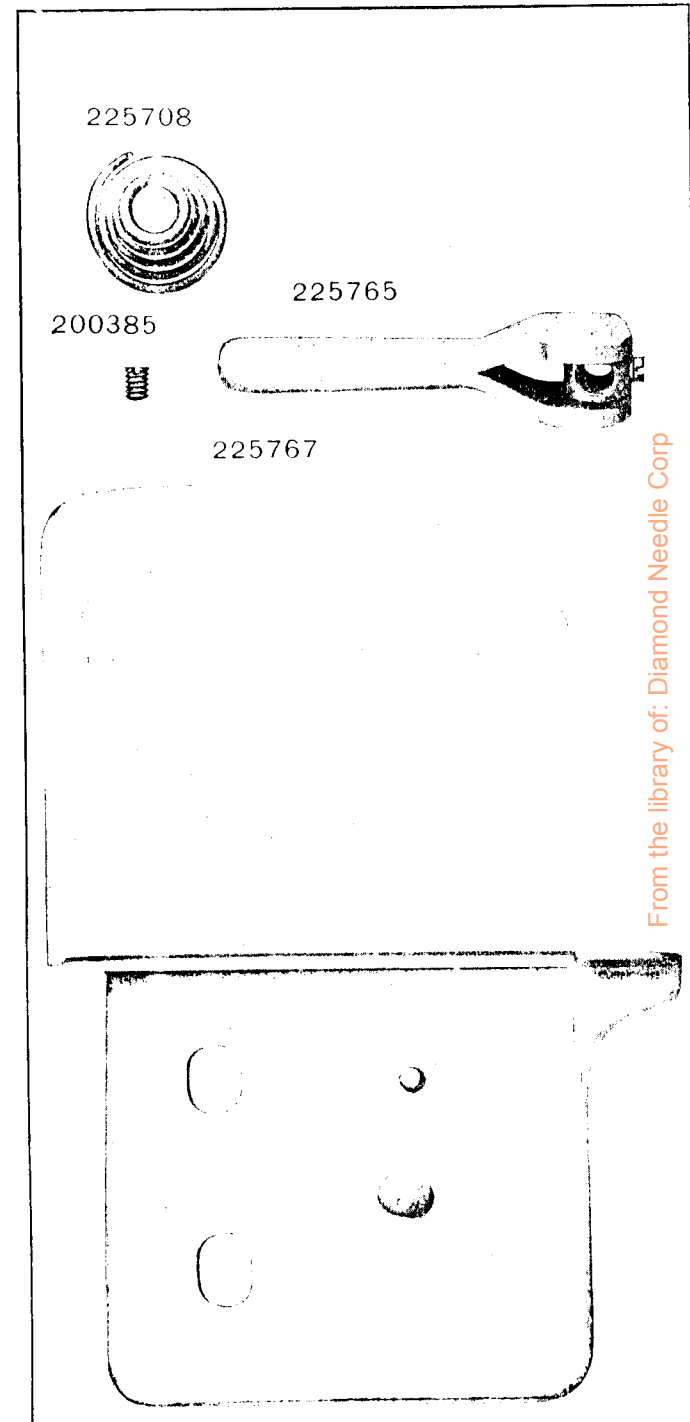


PLATE 10345-FULL SIZE

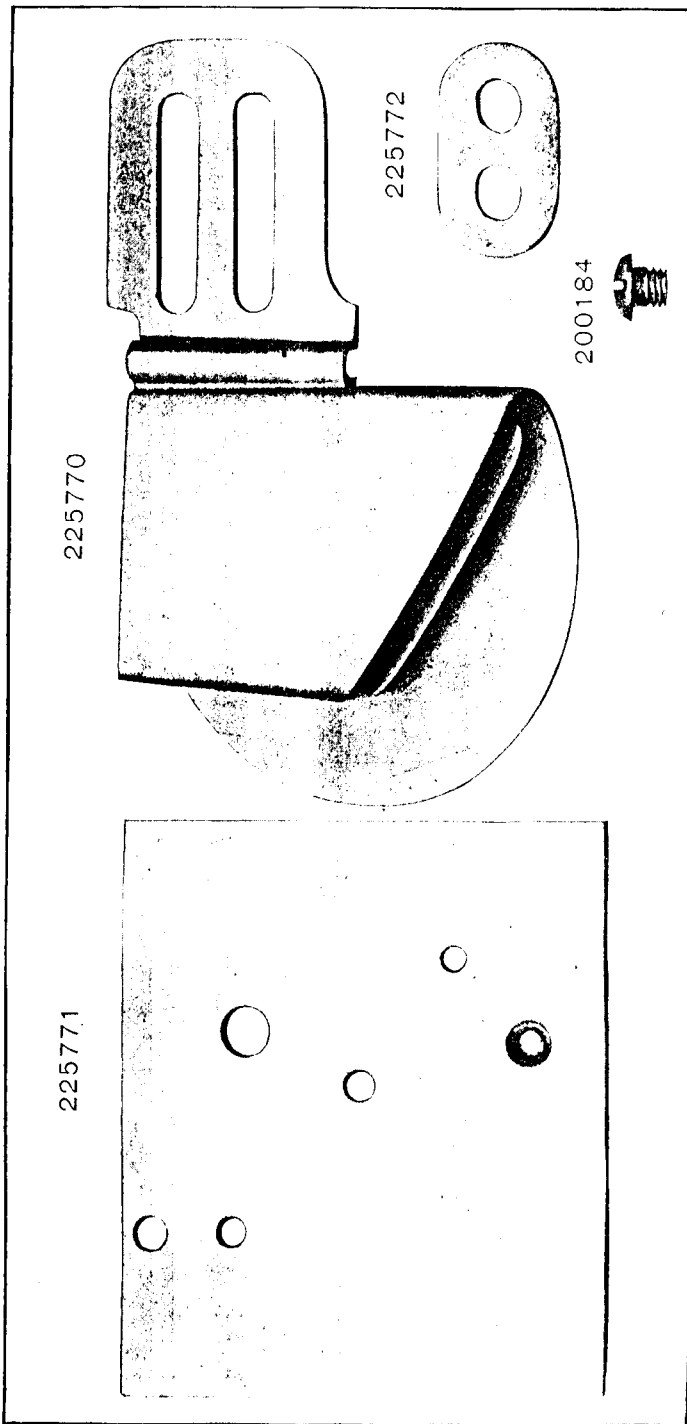
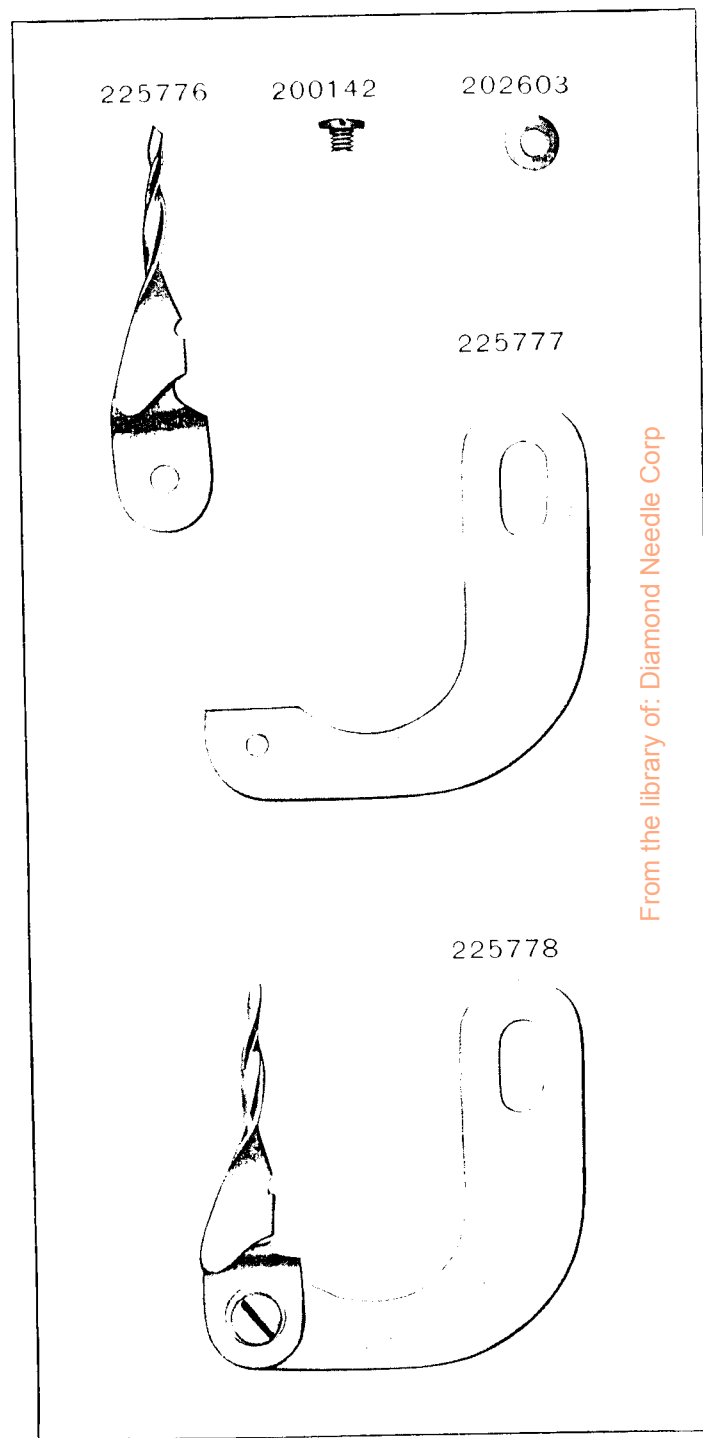


PLATE 10346-FULL SIZE



From the library of: Diamond Needle Corp

PLATE 10347-FULL SIZE

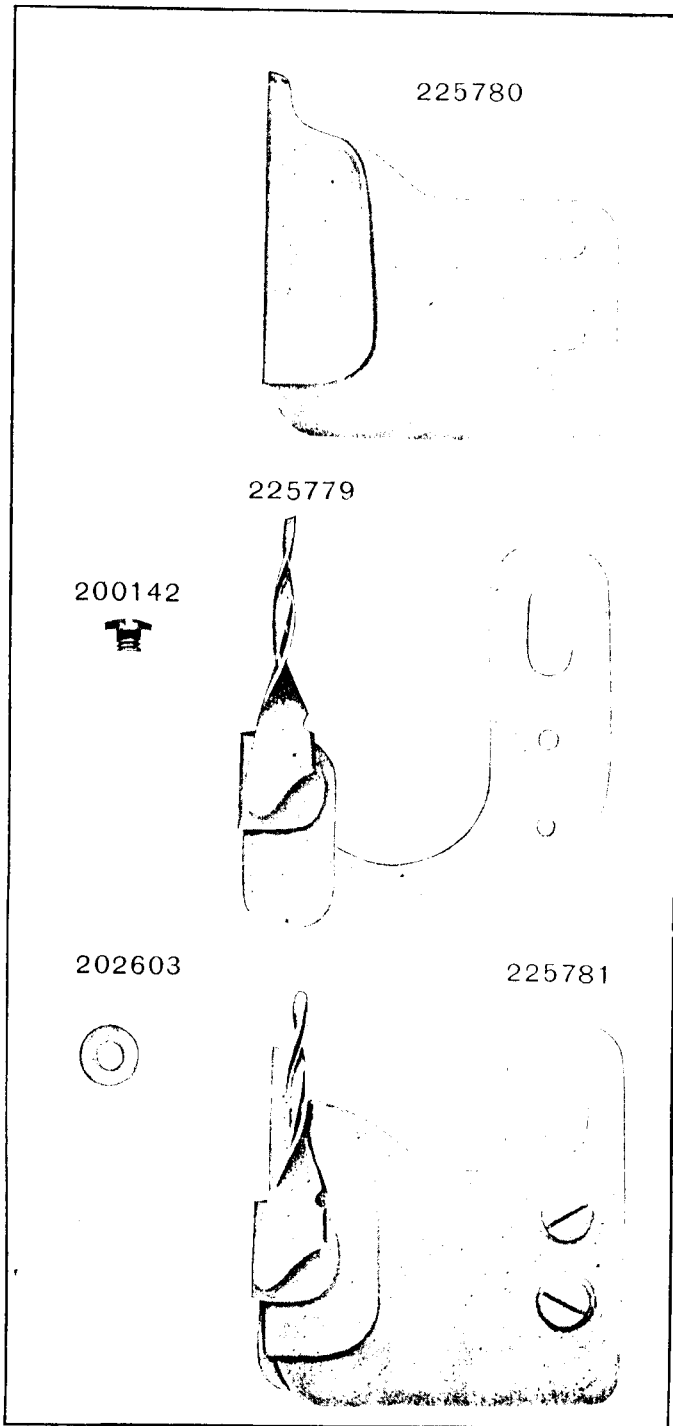
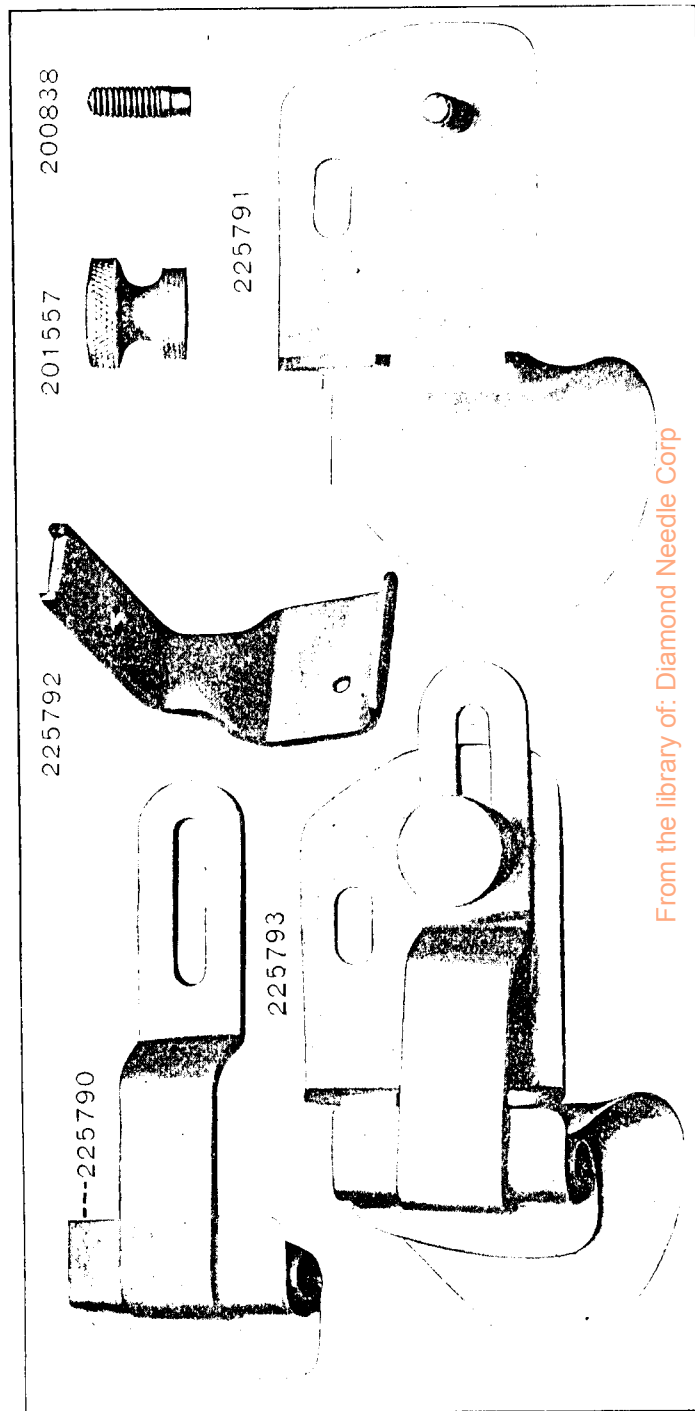


PLATE 10350-FULL SIZE



From the library of: Diamond Needle Corp

PLATE 10353-FULL SIZE

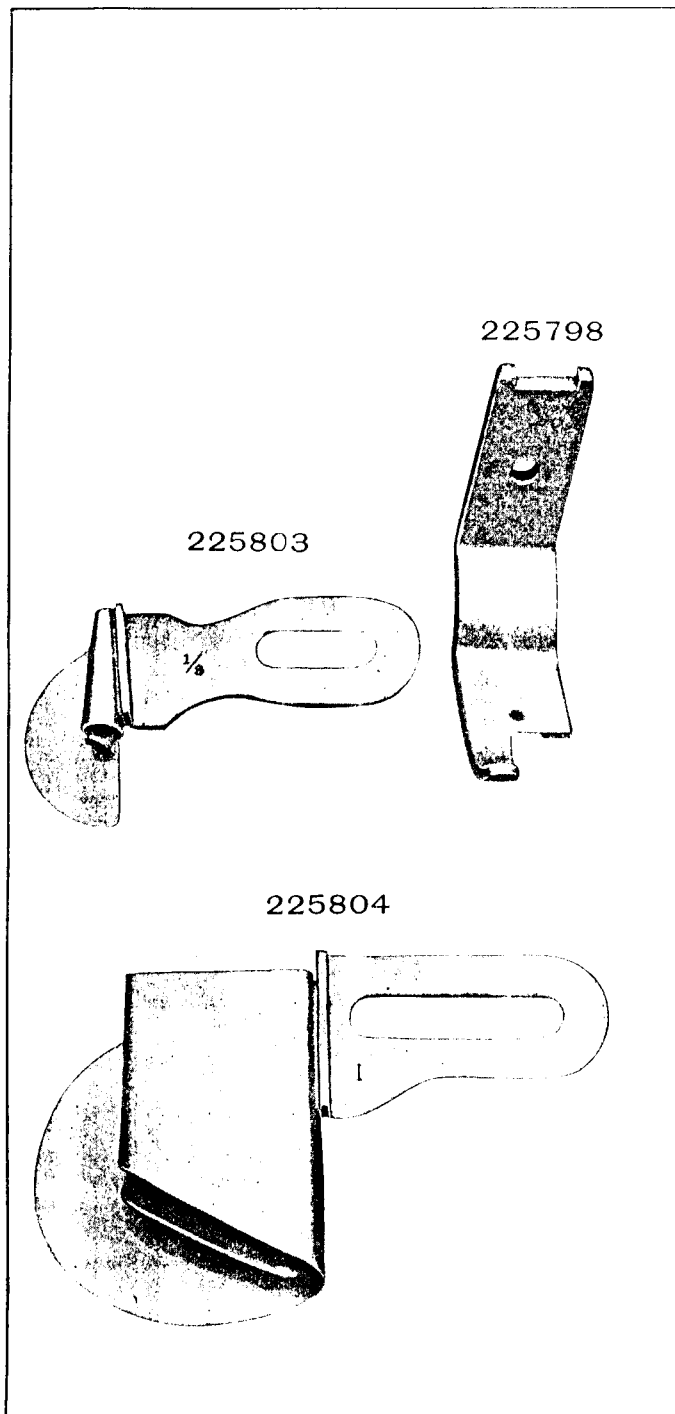


PLATE 10354-FULL SIZE

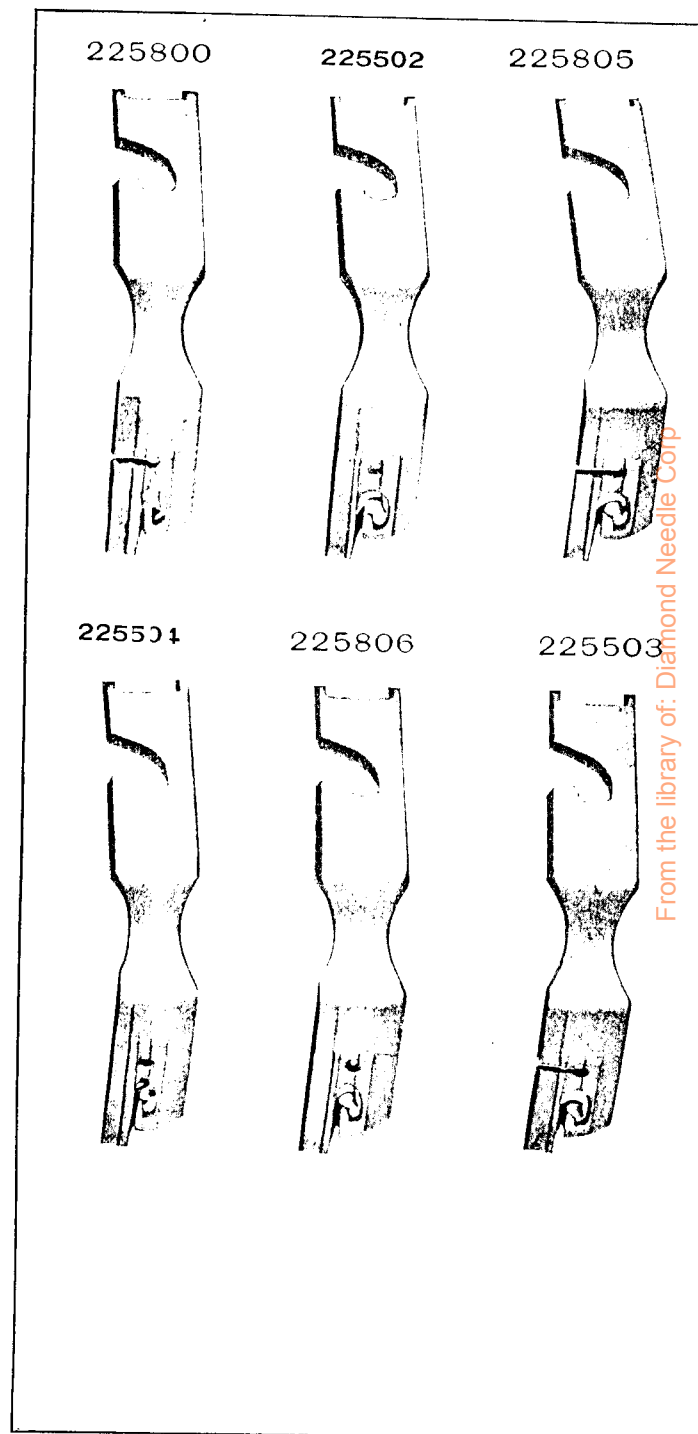


PLATE 10355—FULL SIZE

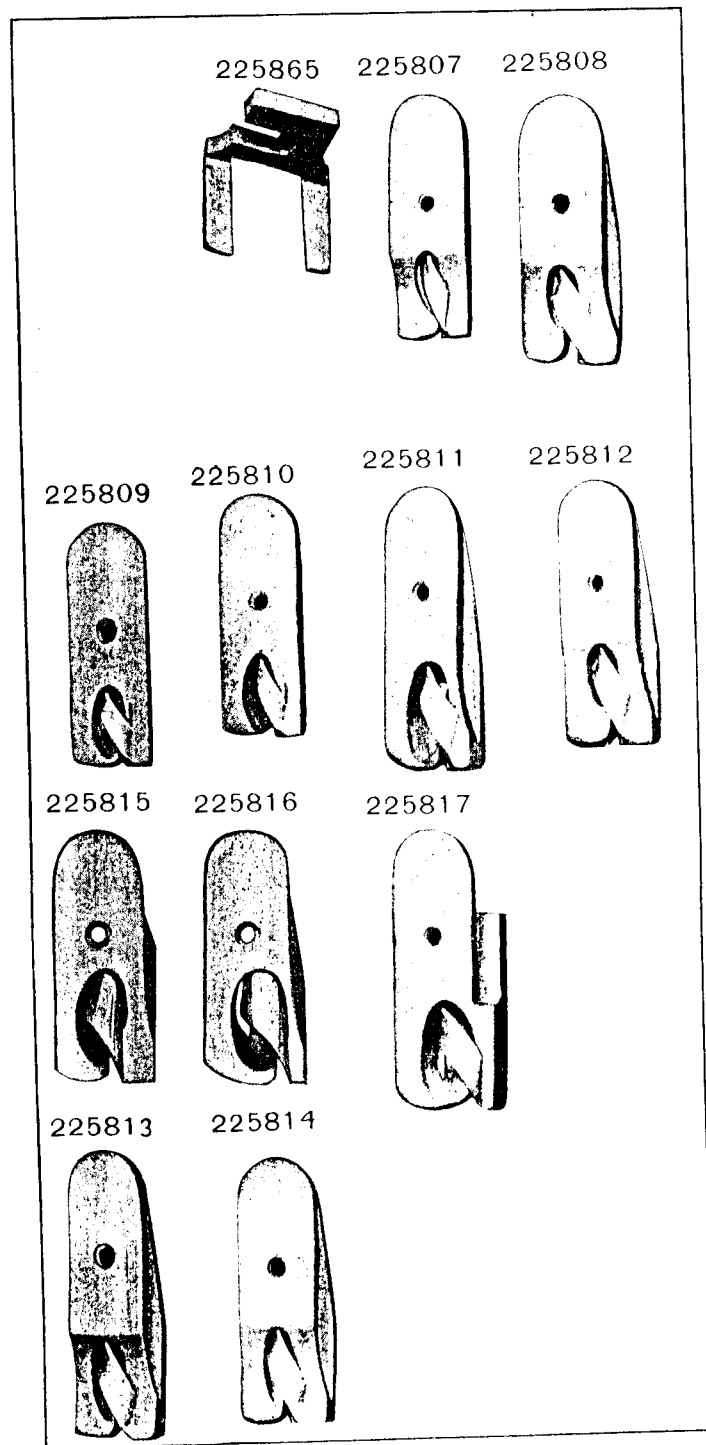


PLATE 10357—ONE-HALF SIZE



From the library of: Diamond Needle Corp

PLATE 10358—ONE-HALF SIZE

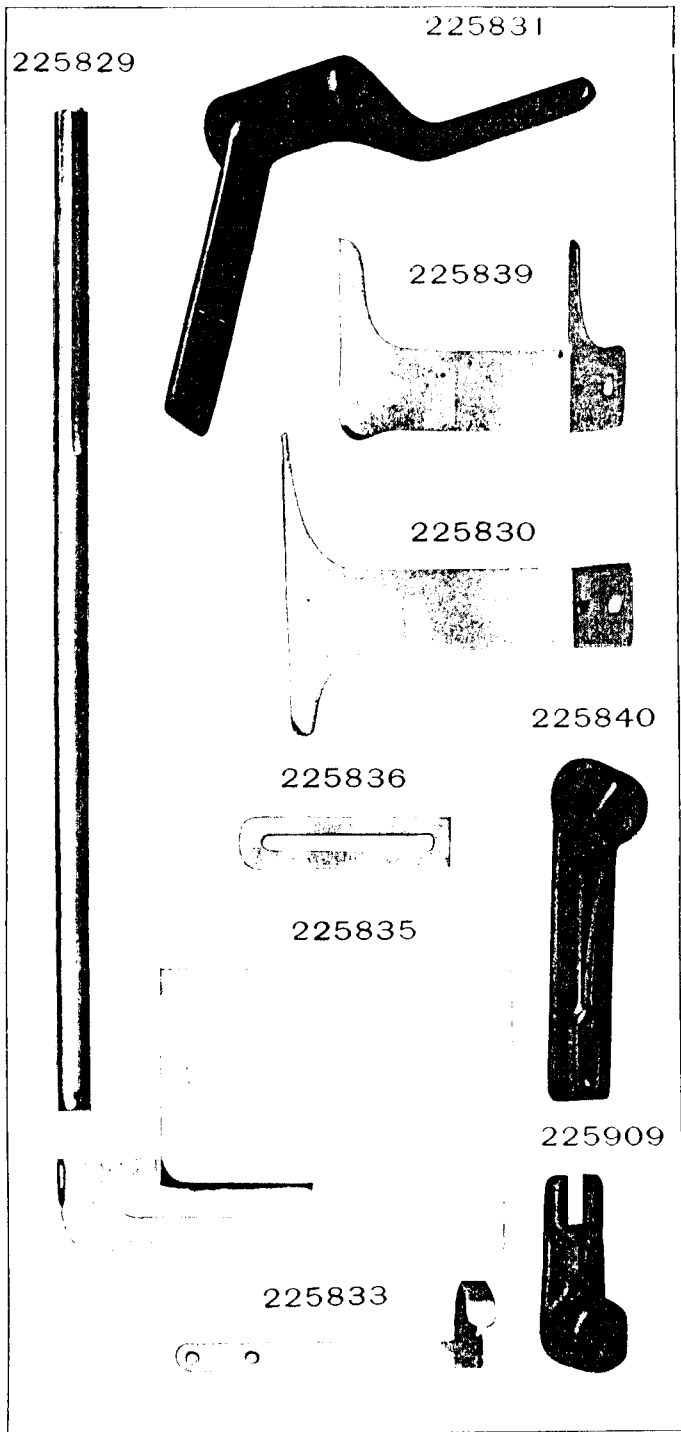
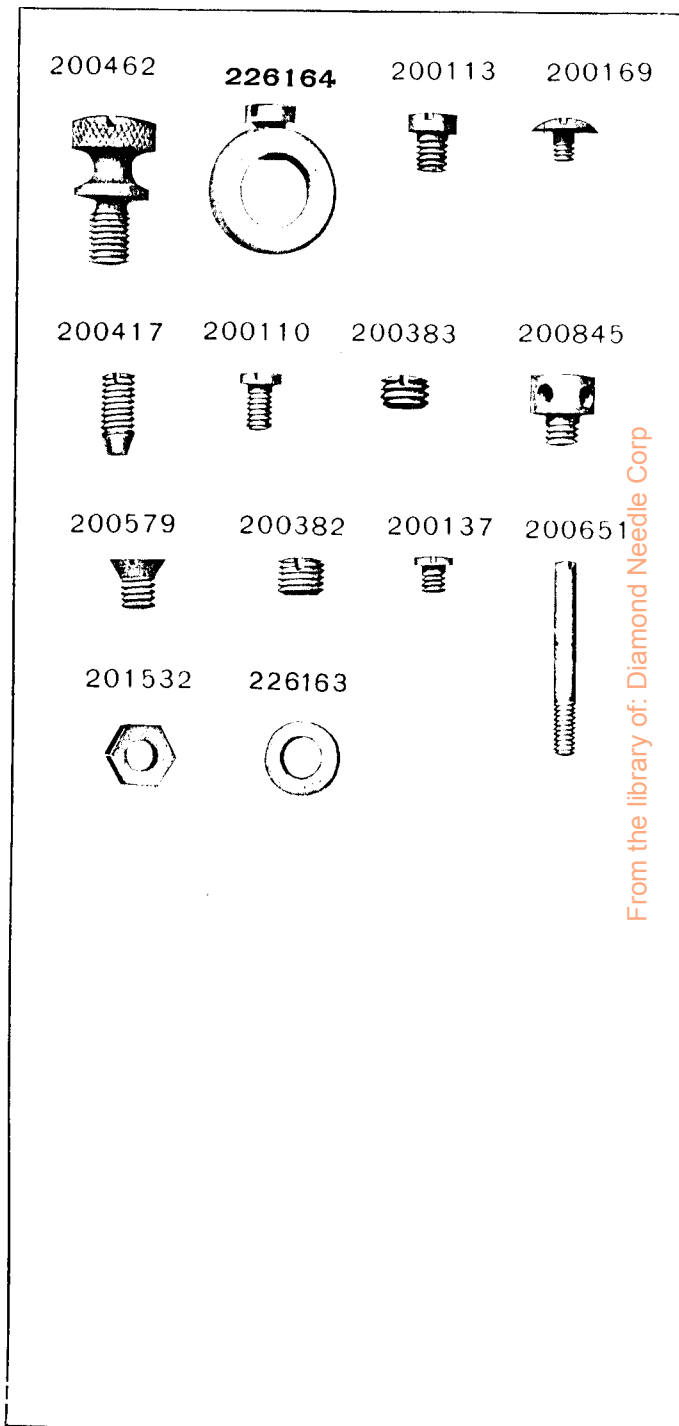


PLATE 10359—FULL SIZE



From the library of: Diamond Needle Corp

PLATE 10360—FULL SIZE

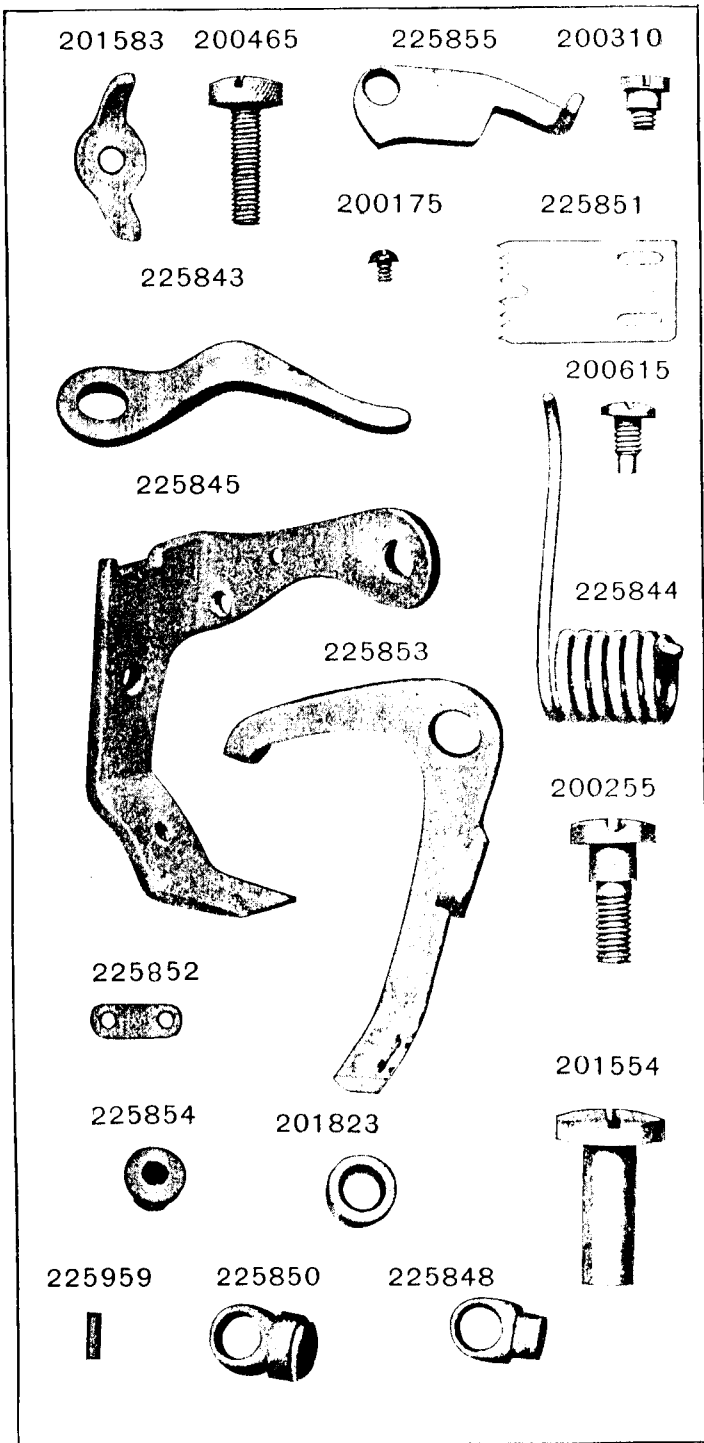
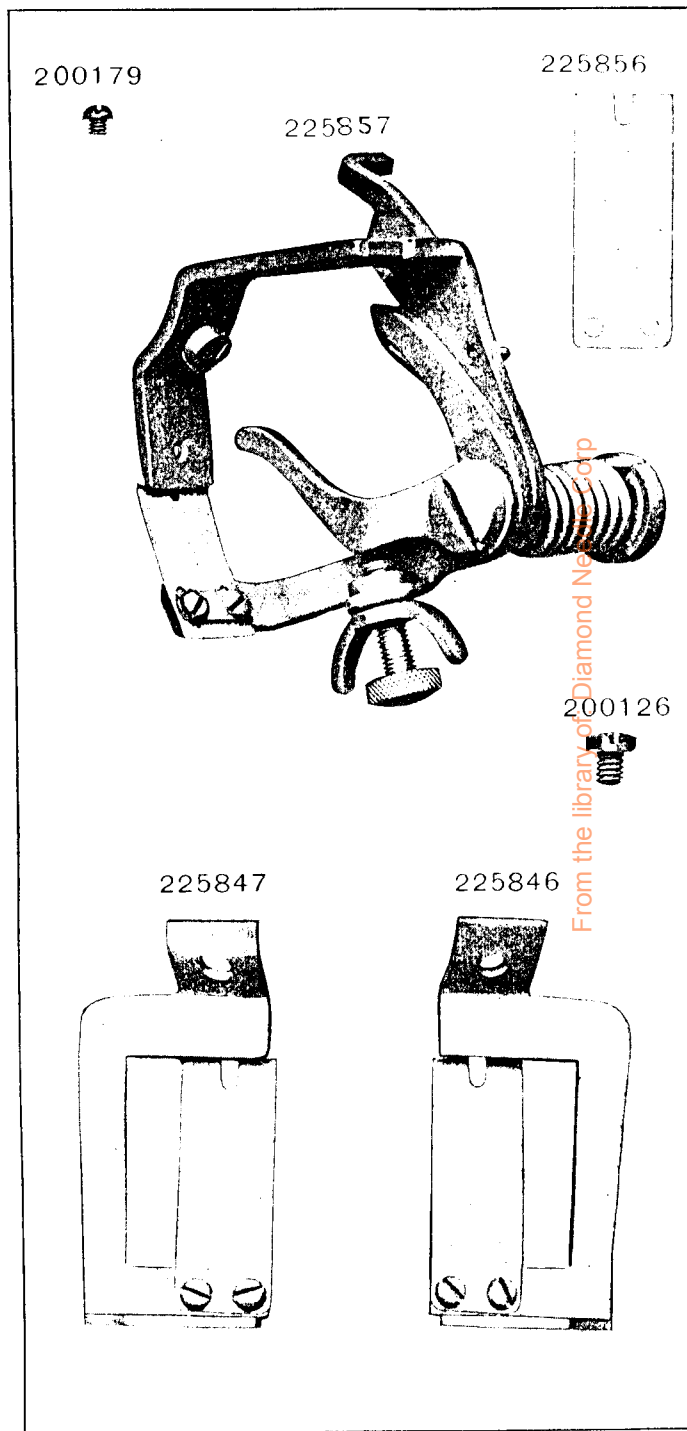


PLATE 10361—FULL SIZE



From the library of Diamond News Corp

PLATE 10365—FULL SIZE

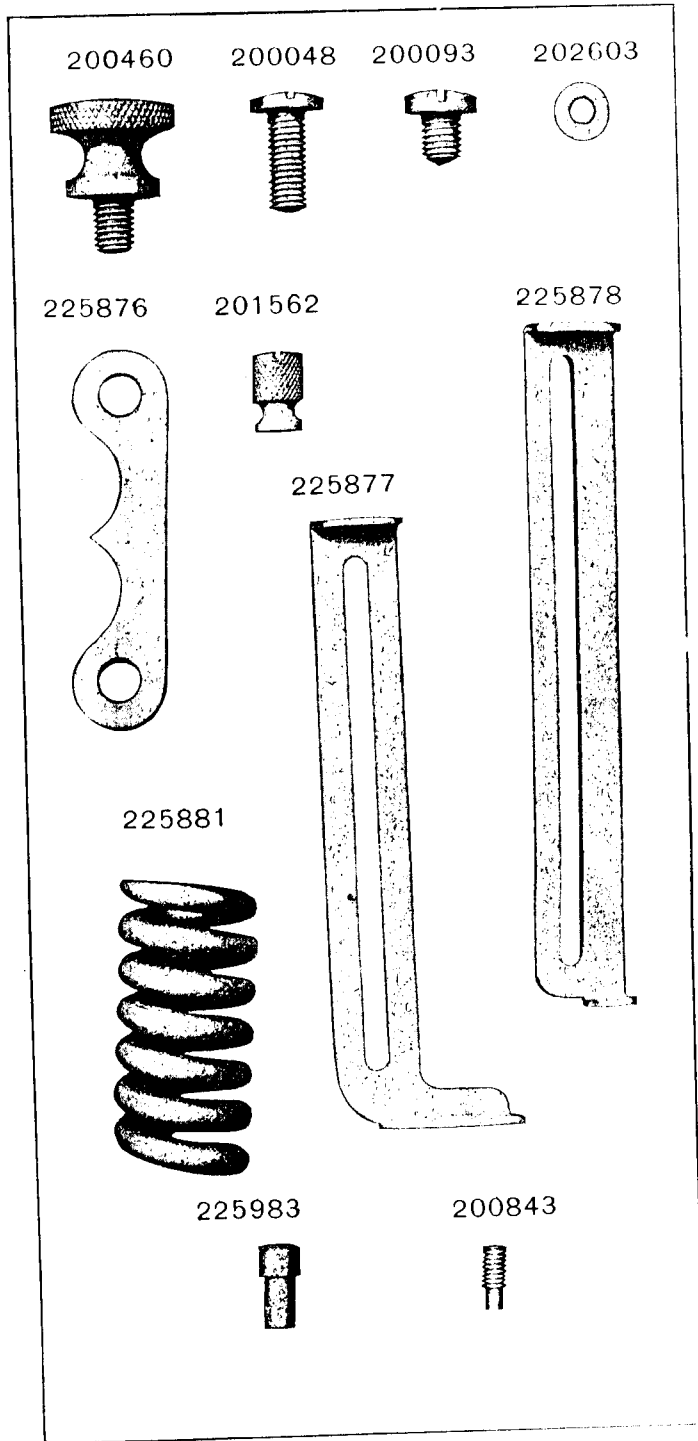
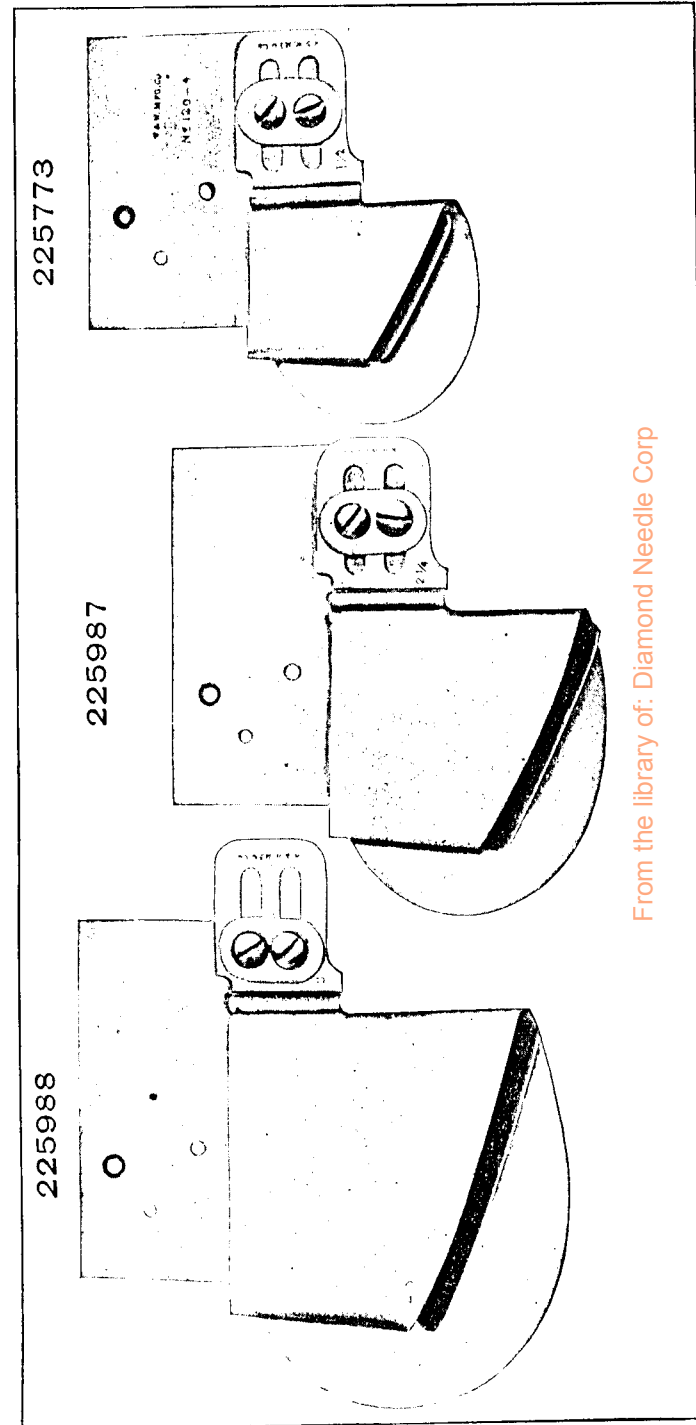


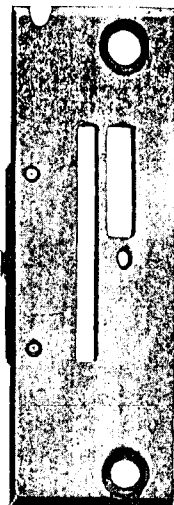
PLATE 10375—ONE-HALF SIZE



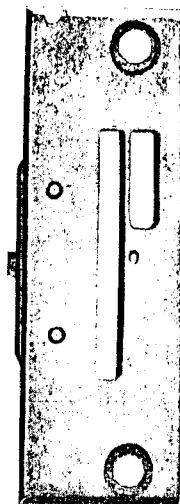
From the library of: Diamond Needle Corp

PLATE 10390-FULL SIZE

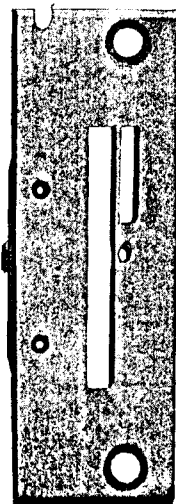
202812



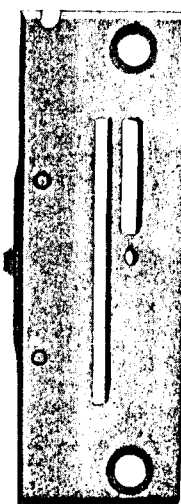
202829



202827



202824

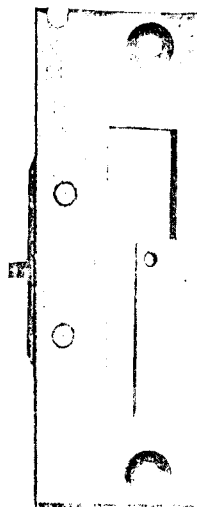


202534

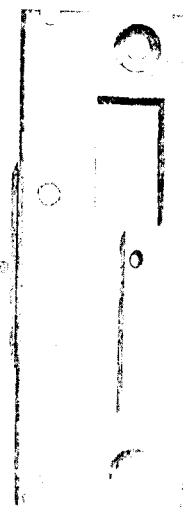


PLATE 10391-FULL SIZE

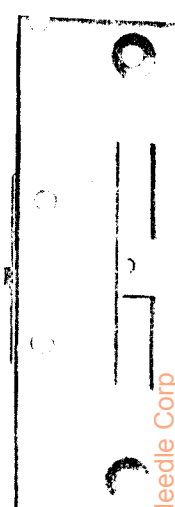
202819



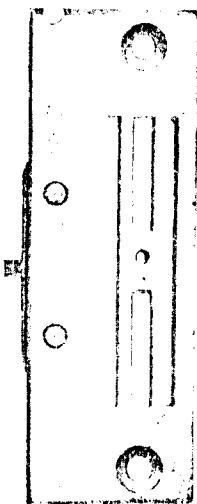
202831



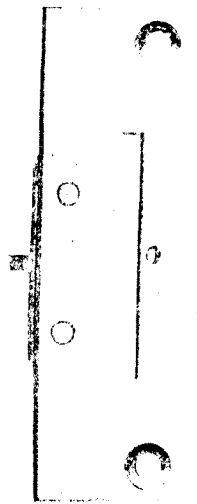
202815



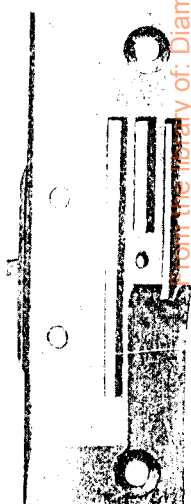
202822



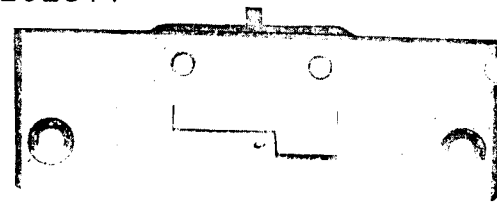
202820



202811



202817



From the library of: Diamond Needle Corp

PLATE 10393—FULL SIZE

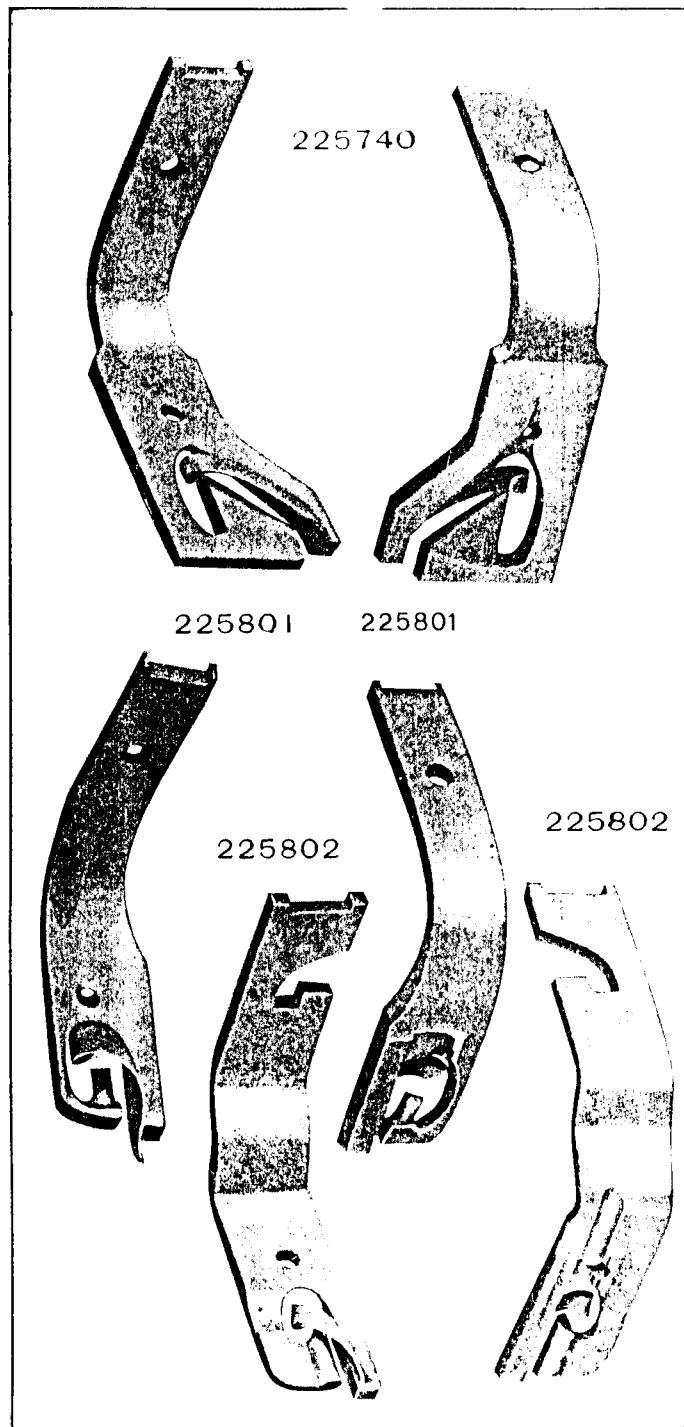
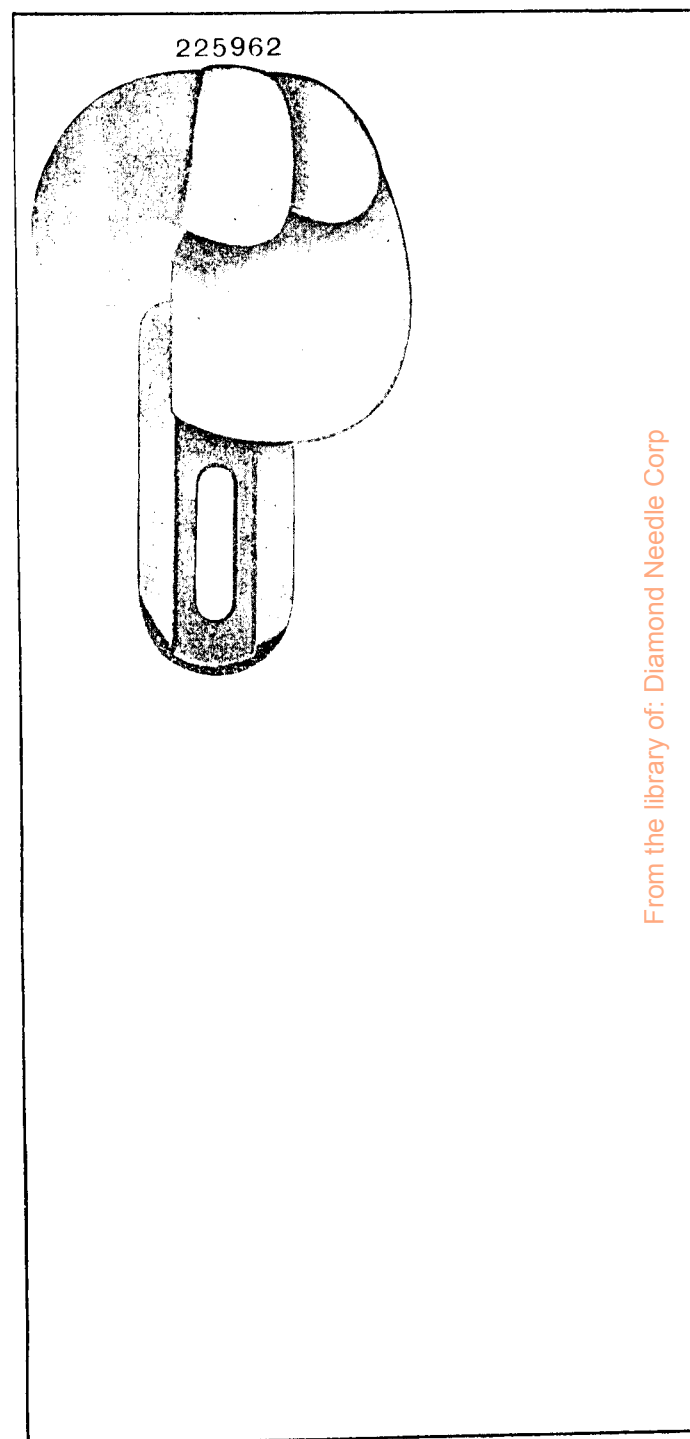


PLATE 10511 —FULL SIZE



From the library of: Diamond Needle Corp

PLATE 10667 - ONE - HALF SIZE

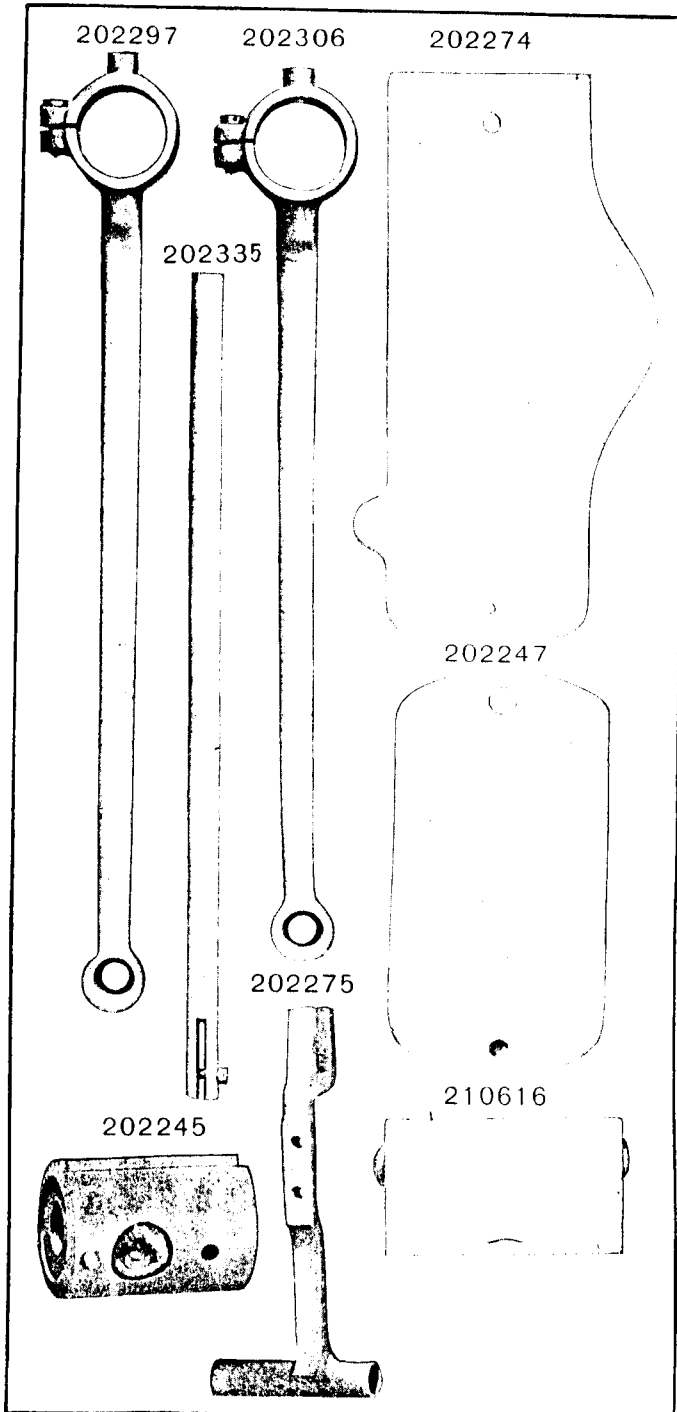


PLATE 10668 - FULL SIZE

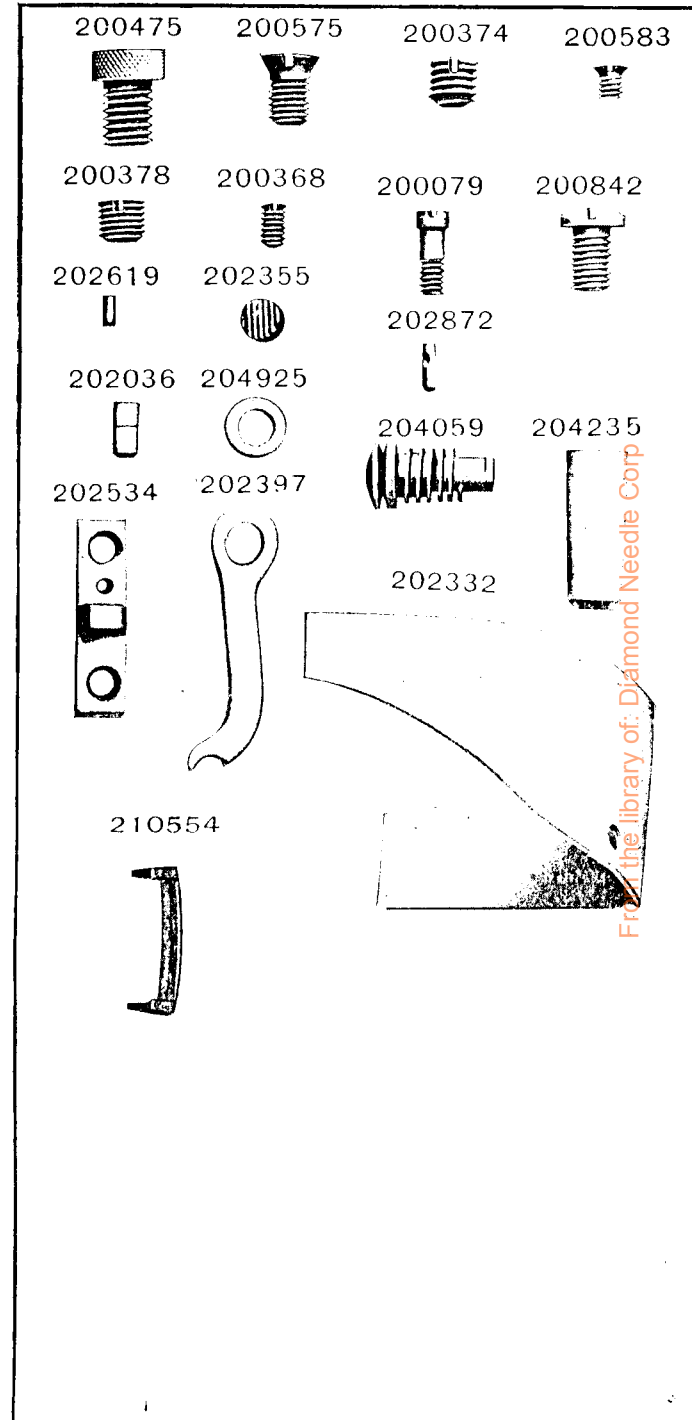
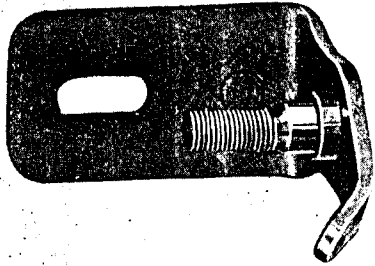


PLATE 10881—FULL SIZE

225461



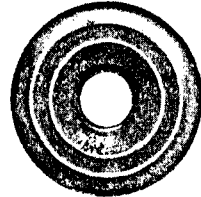
200082



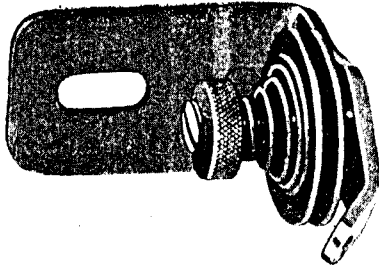
202104



2102



225462



202407



201499

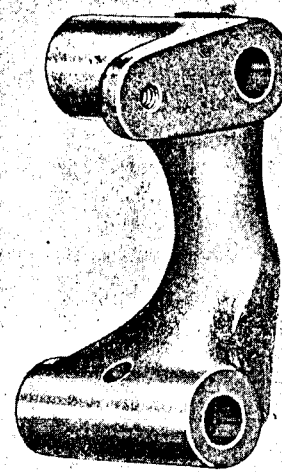


201572



PLATE 10882—FULL SIZE

225453



225455



225438



225457



201052



200056



225456



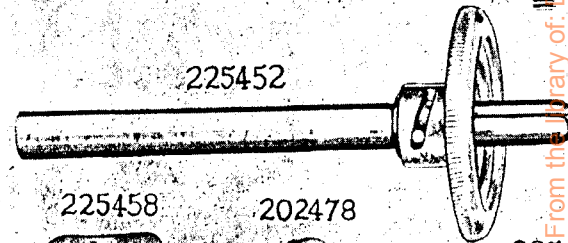
200299



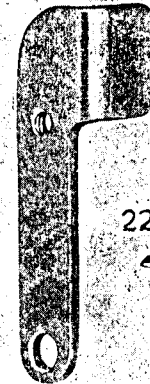
225454



225452



225458



202478



225444



225459



225460



From the Library of: 

PLATE 10883—ONE-FOURTH SIZE

225463



202473



225436

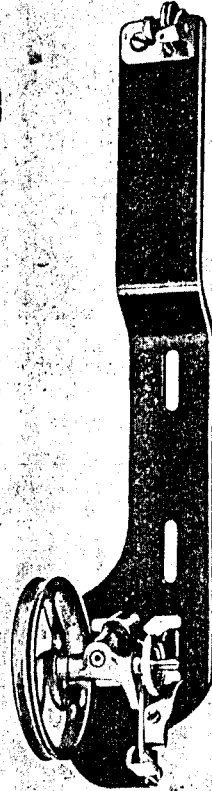
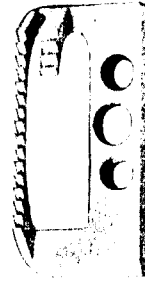
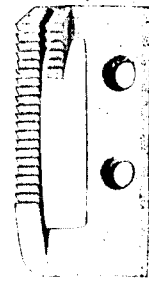


PLATE 10912 -FULL SIZE

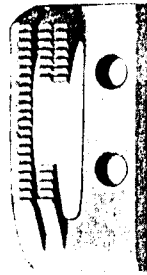
202290



202293



202294



202295



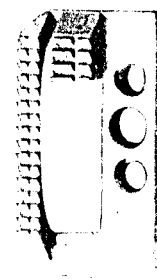
202296



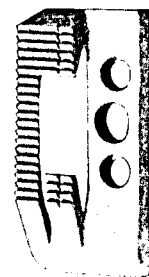
202970



203071



203072



203083



PLATE 10917 -FULL SIZE

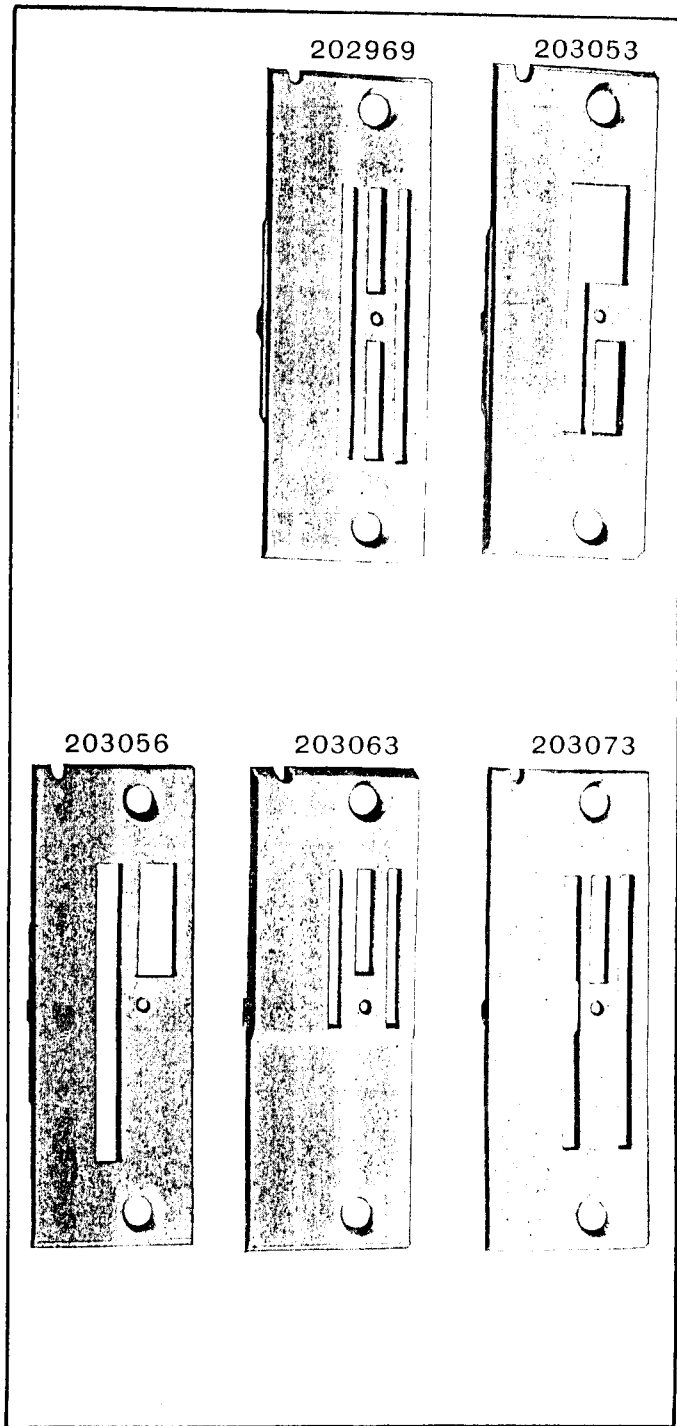


PLATE 10923 -FULL SIZE

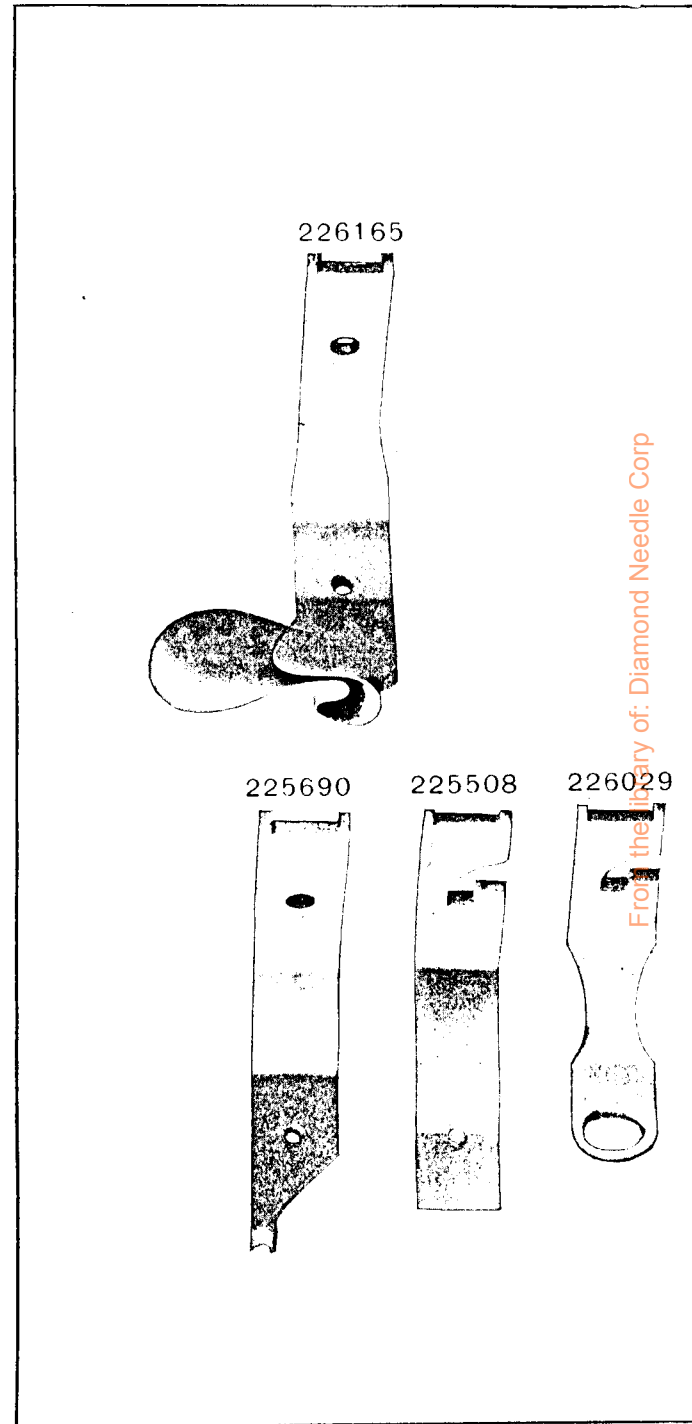


PLATE 10925 -FULL SIZE

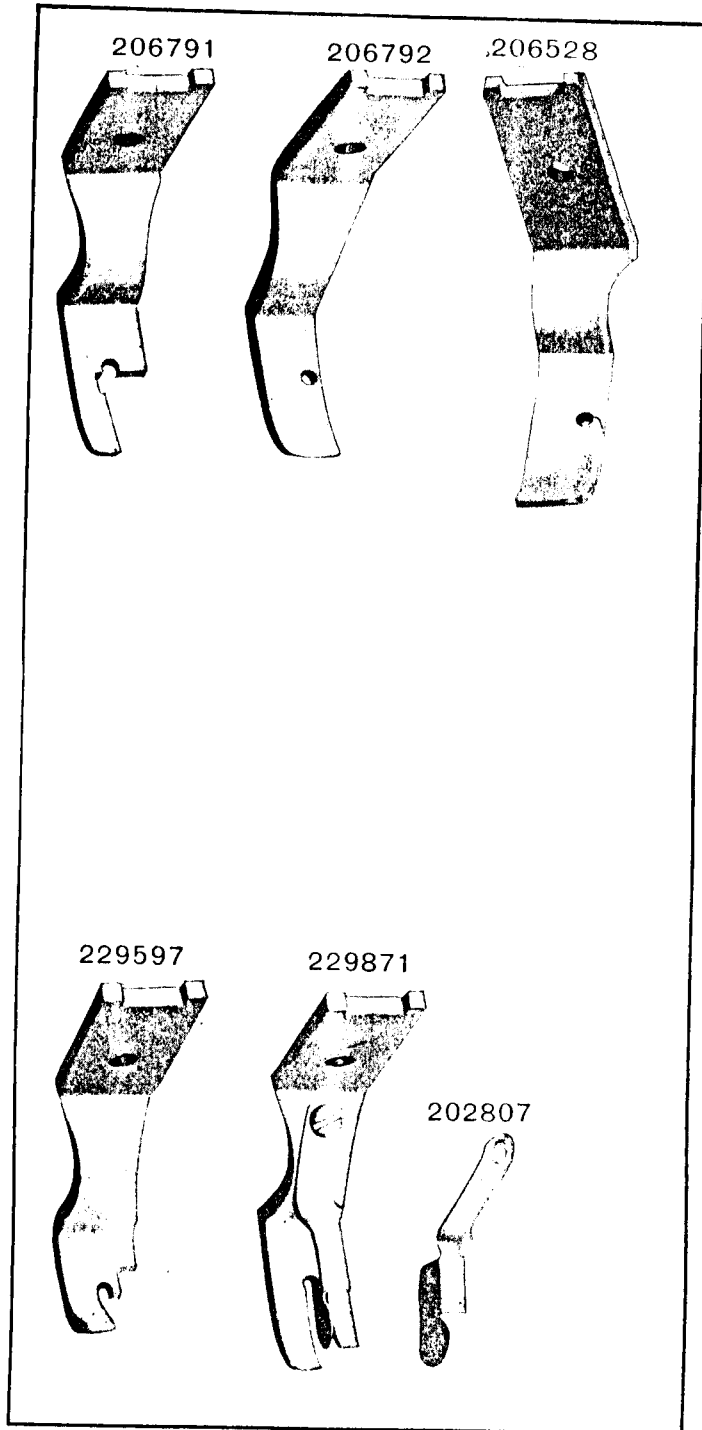


PLATE 10926 -FULL SIZE

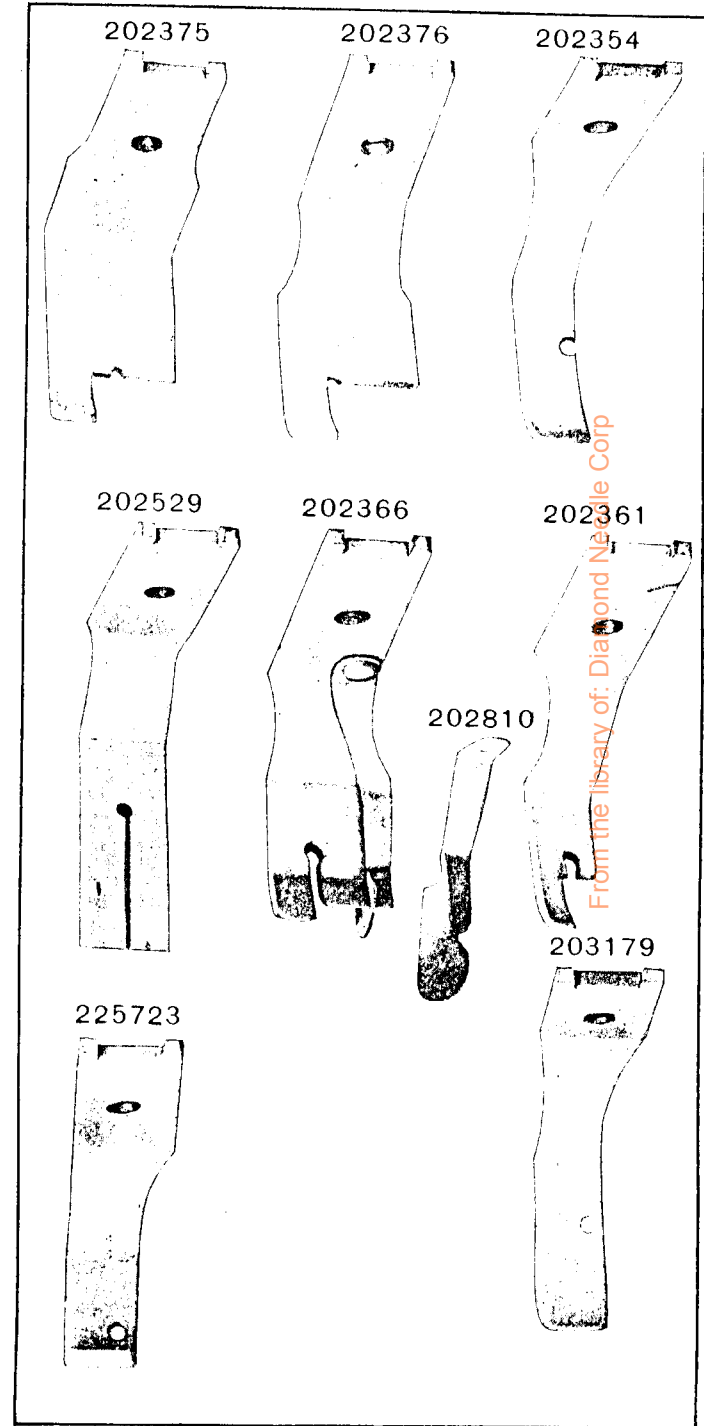
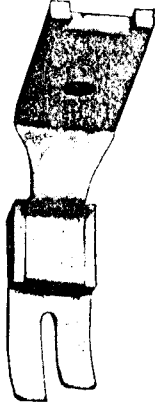
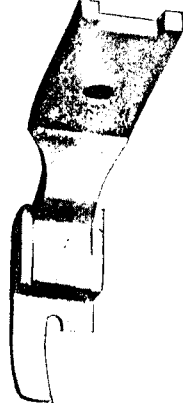


PLATE 10927 -FULL SIZE

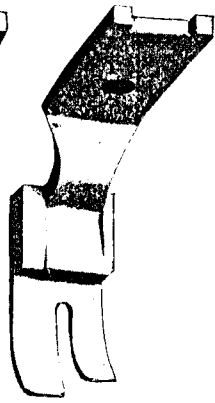
229864



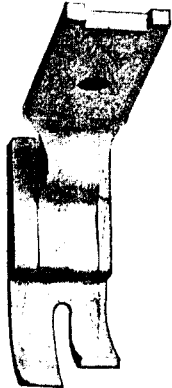
229865



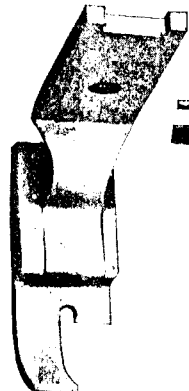
229863



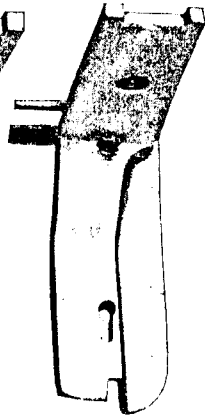
229867



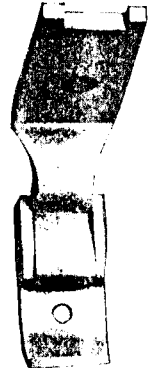
229868



206790



202351



202809

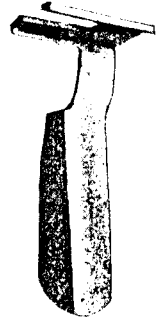


PLATE 10929 -FULL SIZE

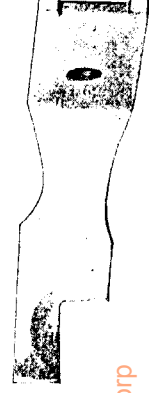
206794



229857



229858



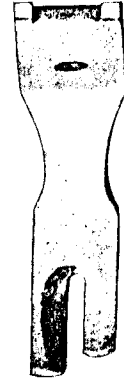
206785



229856



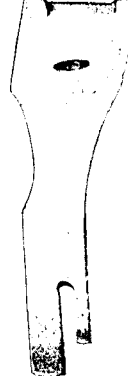
202418



206788



206786



From the library of: Diamond Netting Corp

PLATE 10935 - ONE-HALF SIZE

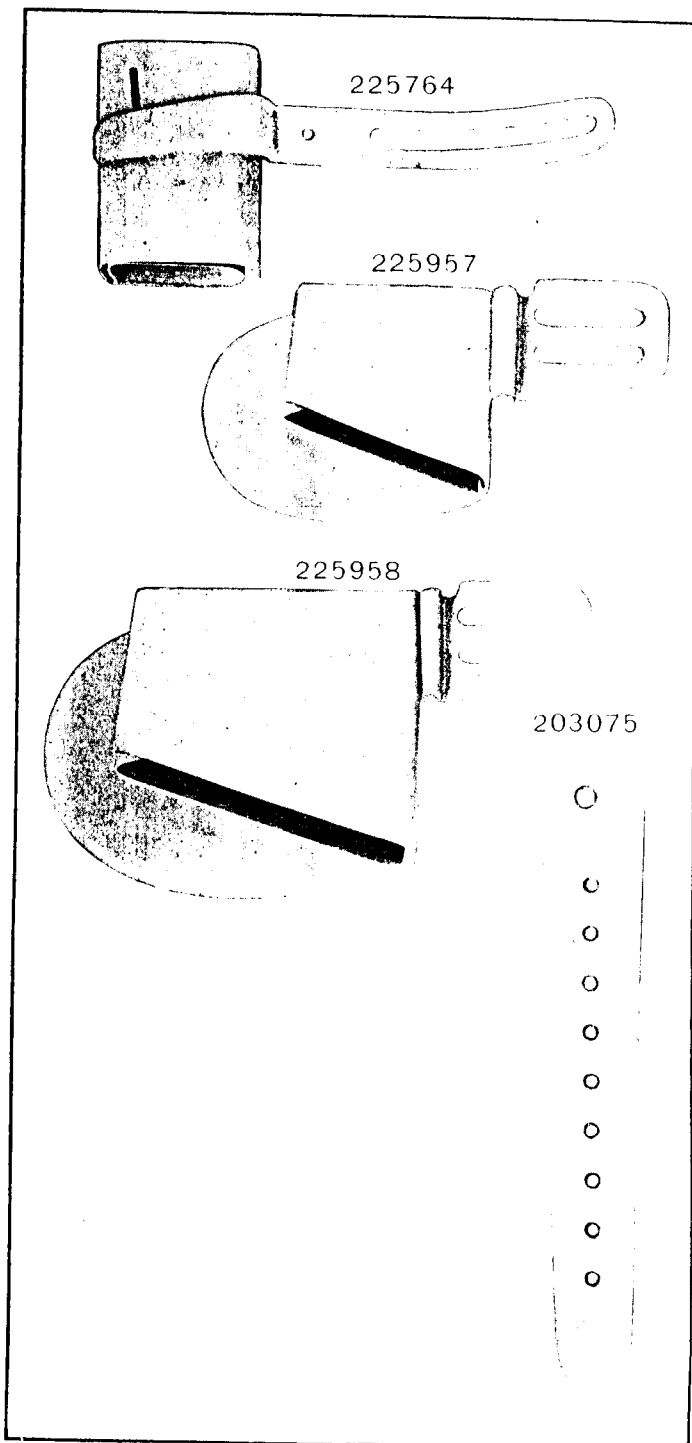
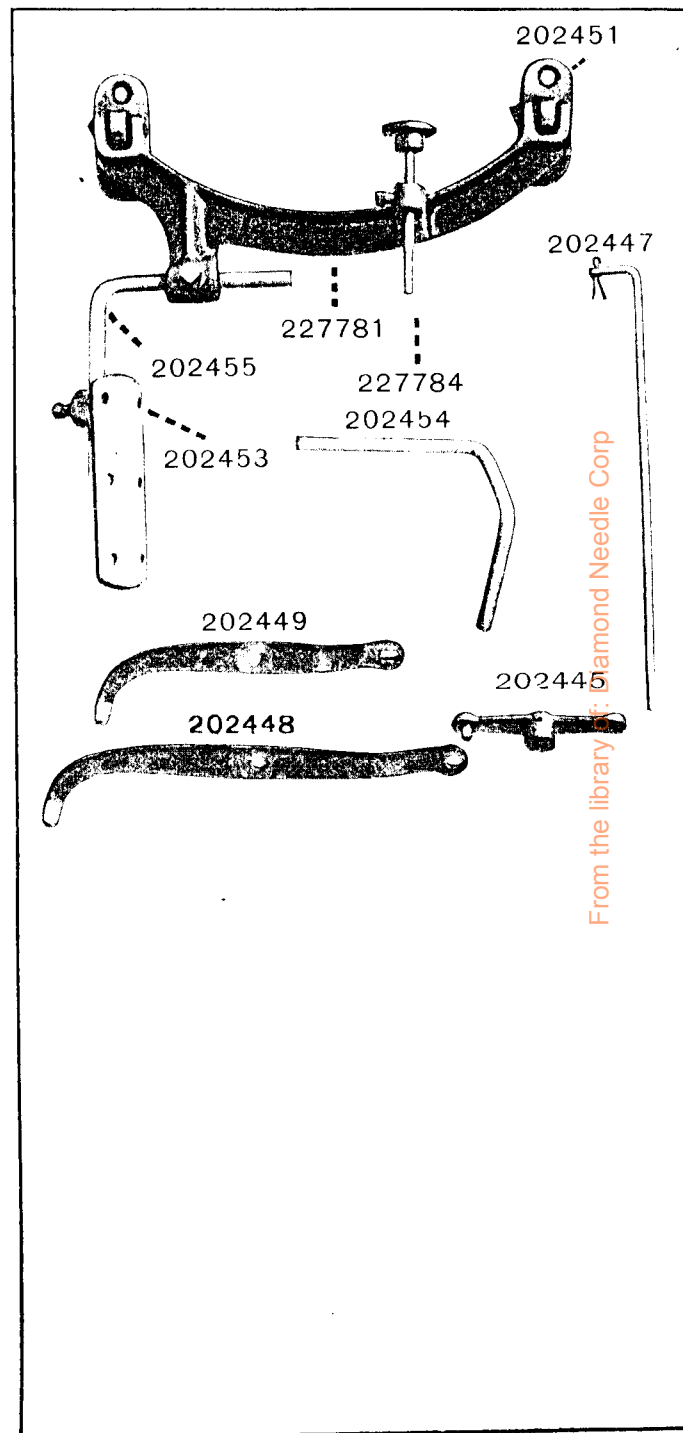


PLATE 10936 - ONE-FOURTH SIZE



From the library of: **Diamond Needle Corp**

PLATE 11598—FULL SIZE

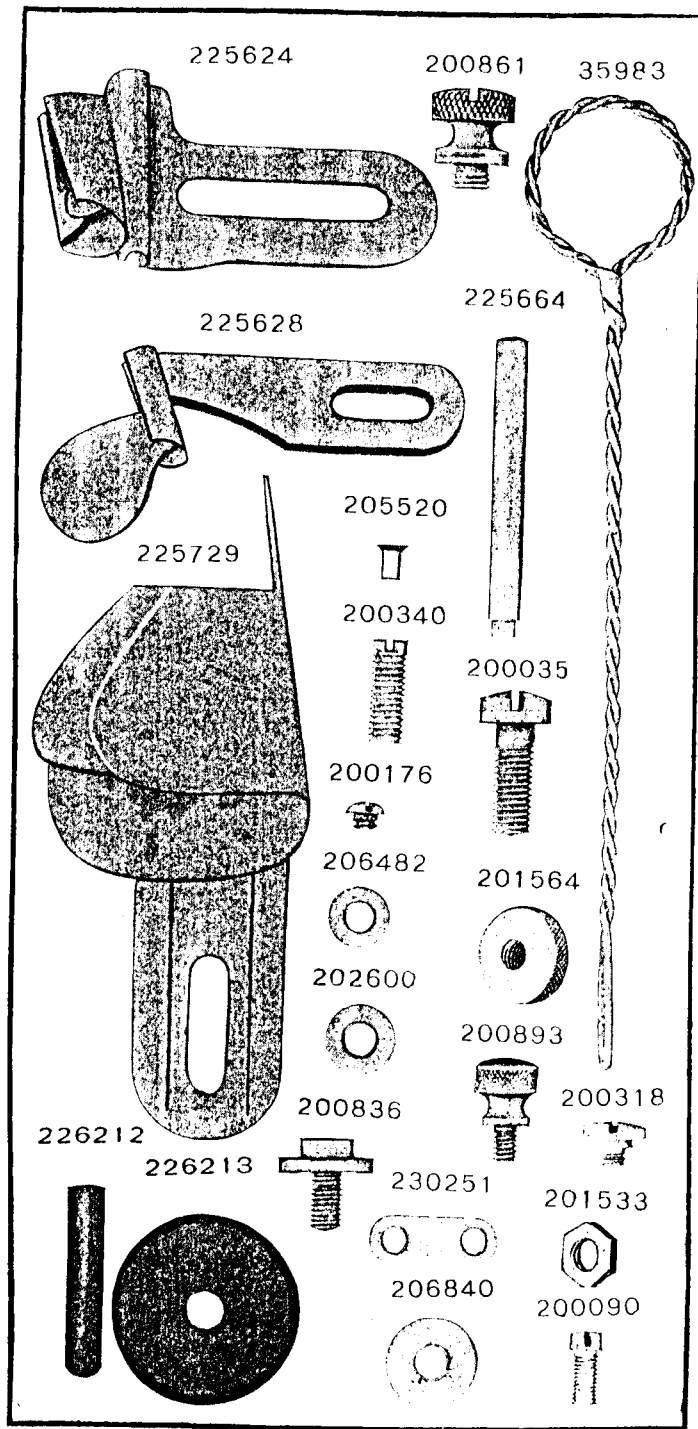
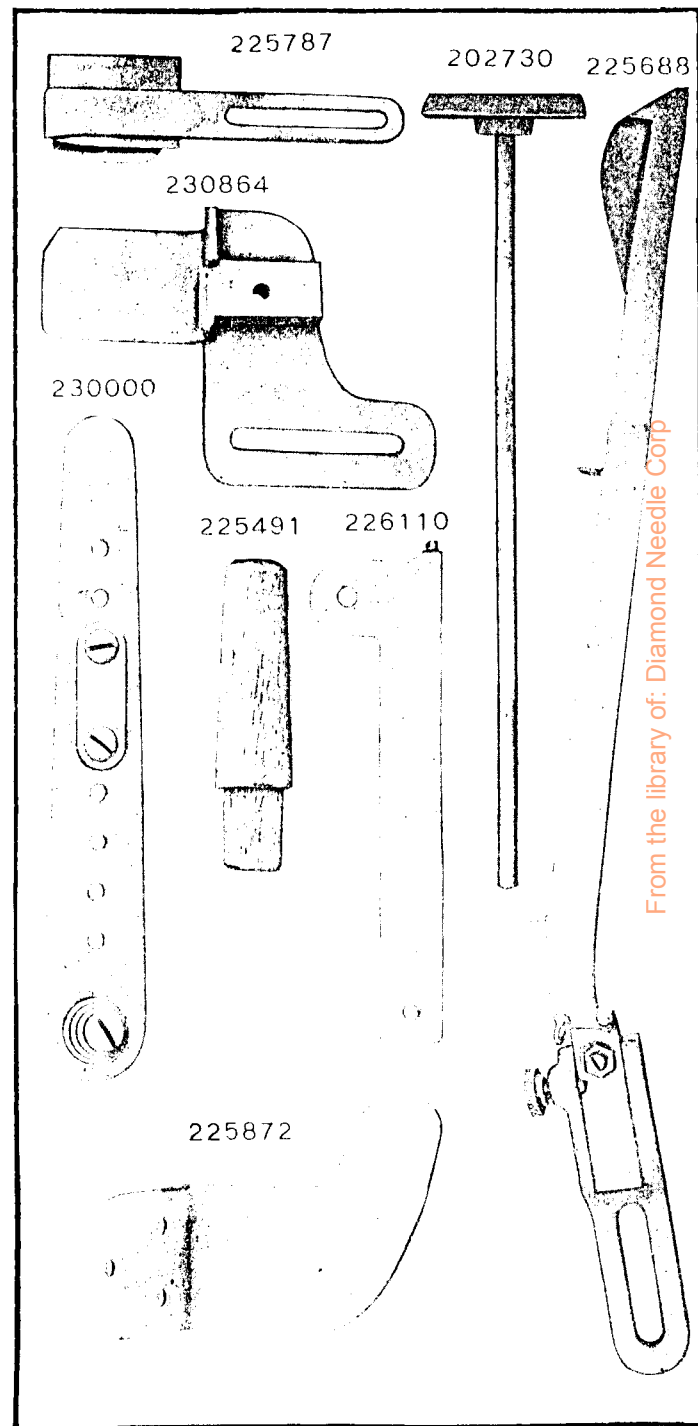


PLATE 11599—ONE-HALF SIZE



From the library of: Diamond Needle Corp

PLATE 11600-FULL SIZE

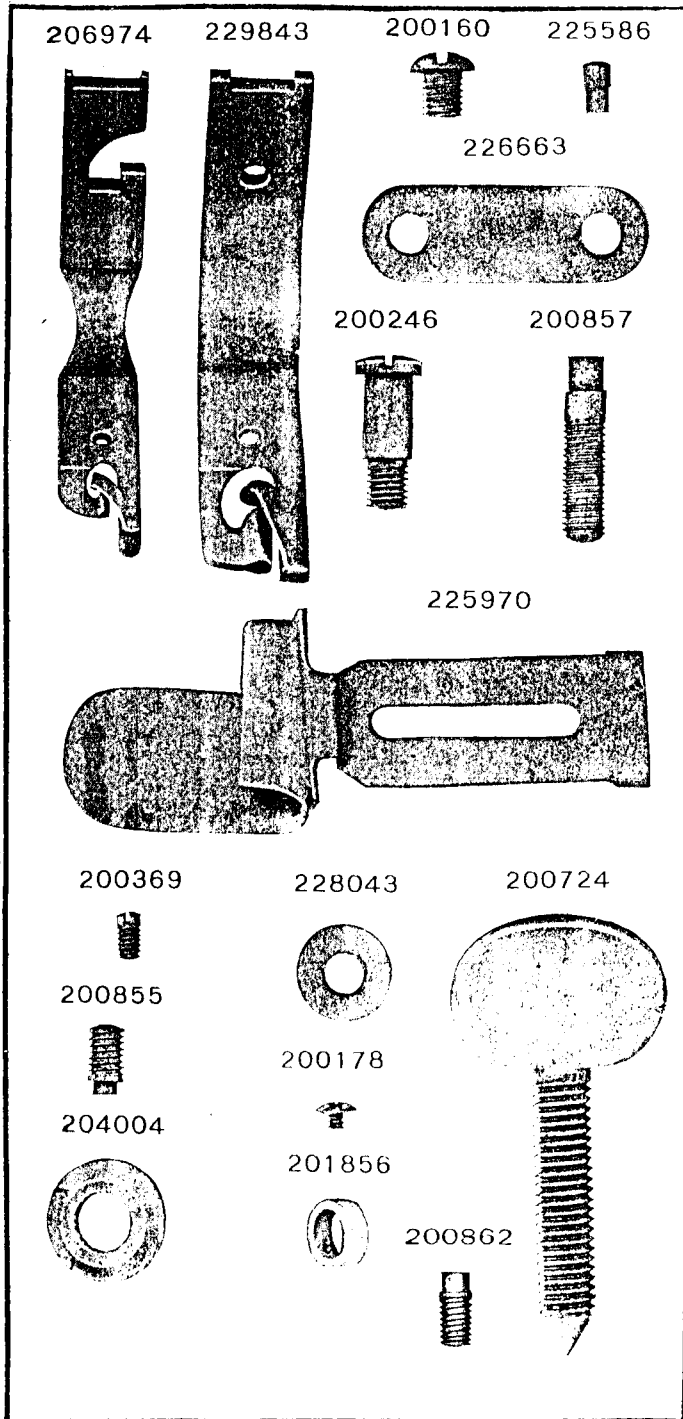
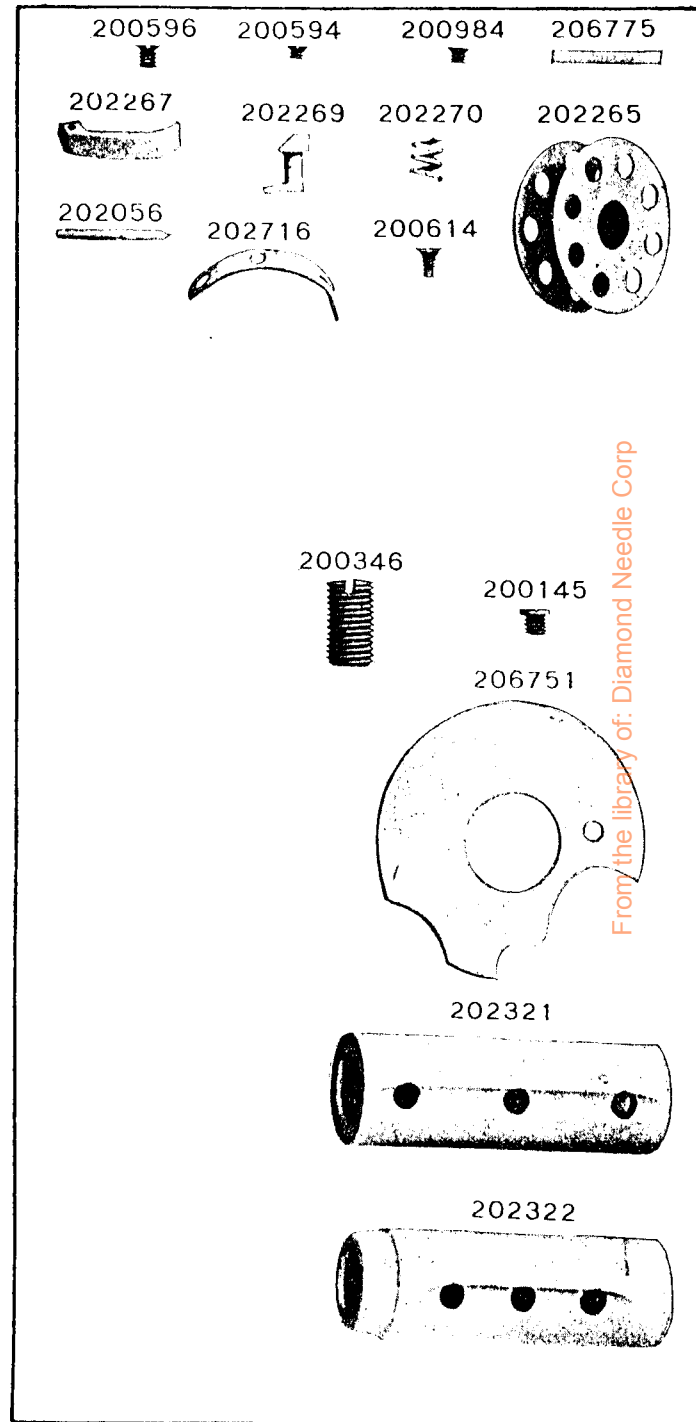


PLATE 11671-FULL SIZE



From the library of: Diamond Needle Corp

PLATE 13352—ONE-HALF SIZE

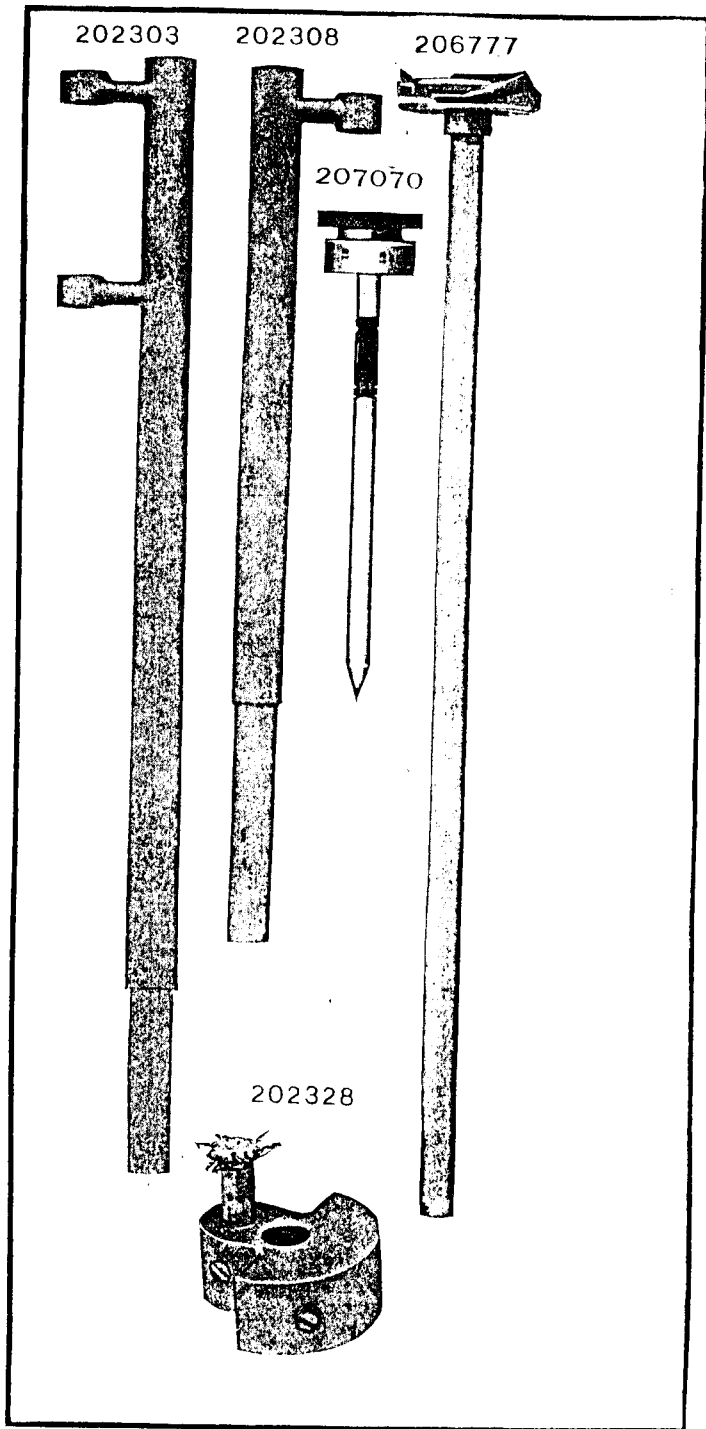


PLATE 13353—FULL SIZE

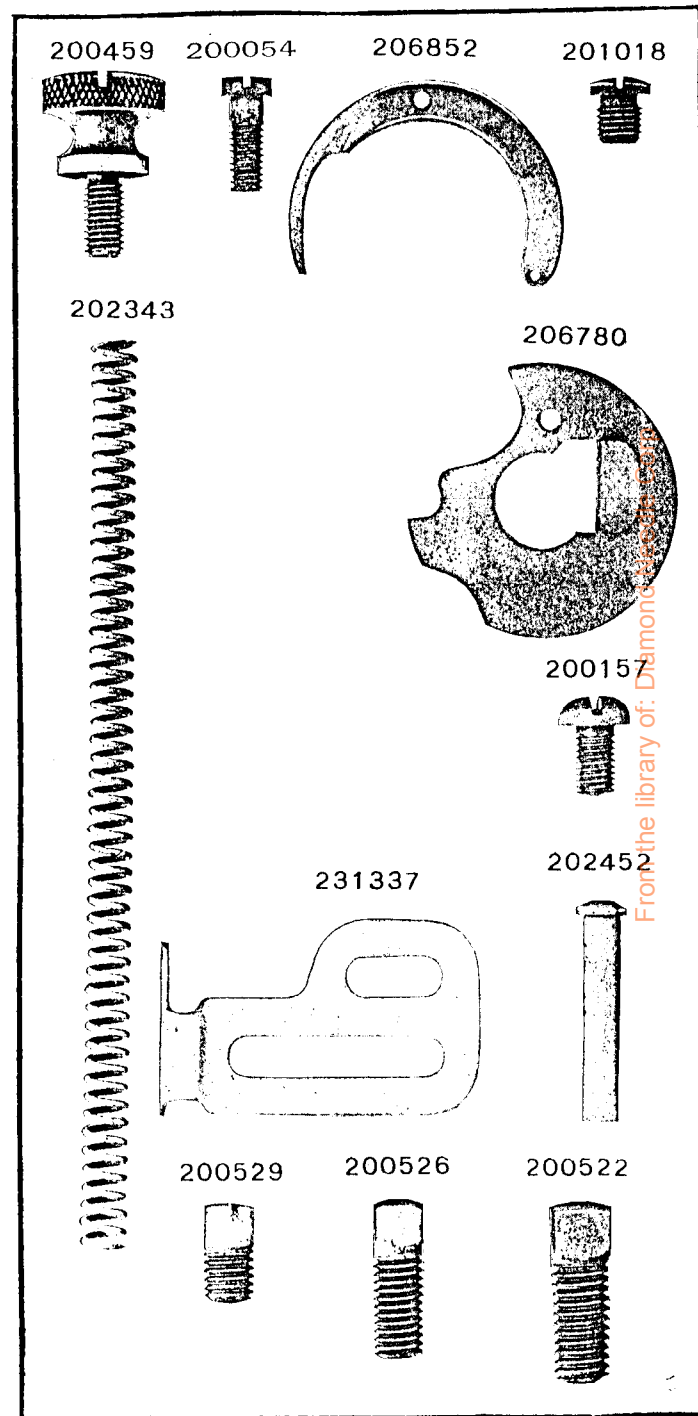
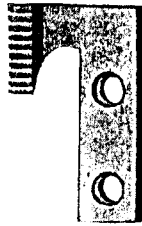


PLATE 13354--FULL SIZE

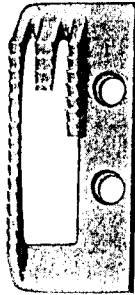
203136



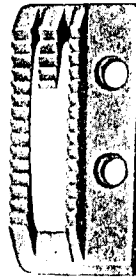
230625



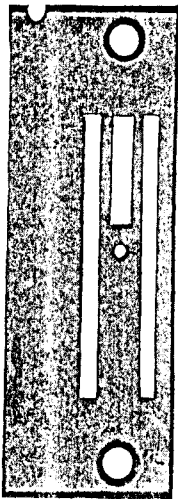
203173



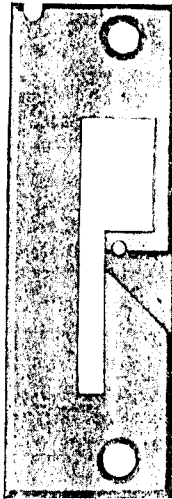
203417



202818



202811



202828

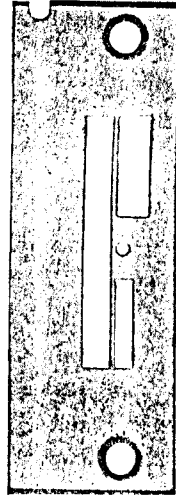
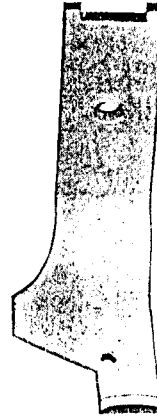
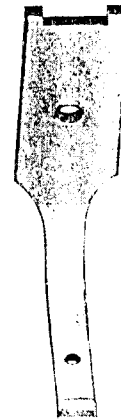


PLATE 13355--FULL SIZE

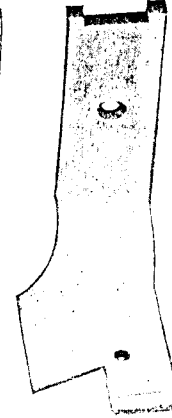
203198



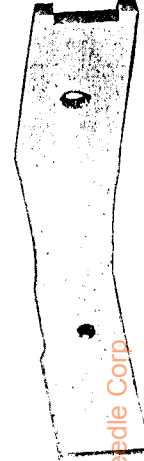
203199



203200



202373



206841



206779



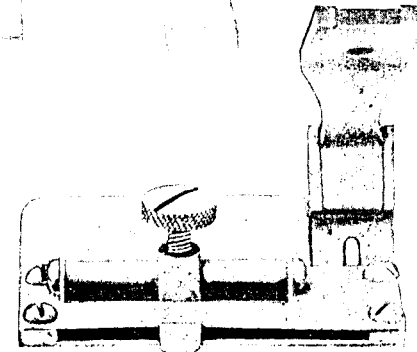
206787



26608



231238



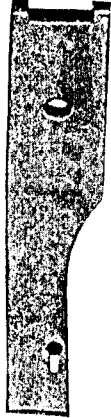
From the library of Diamond Needle Corp

PLATE 13356-FULL SIZE

225702



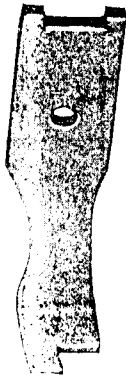
225862



225949



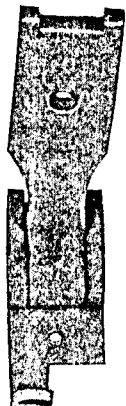
229880



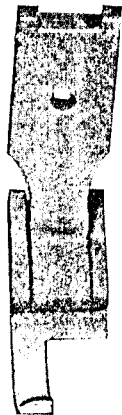
206998



202371



202372



203323



200543



200904



202572



202090



206842

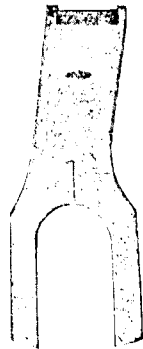
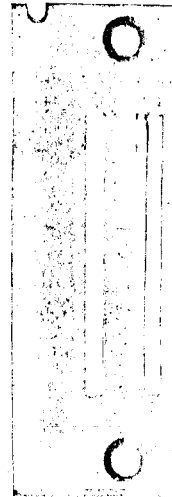
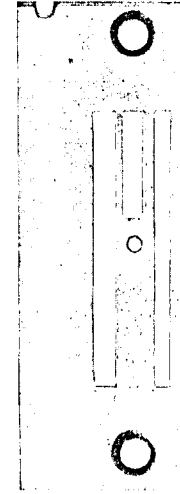


PLATE 13357-FULL SIZE

202951



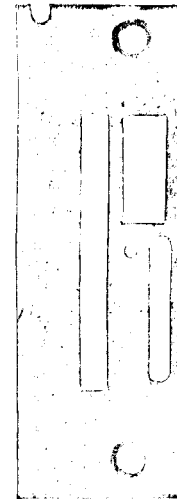
203111



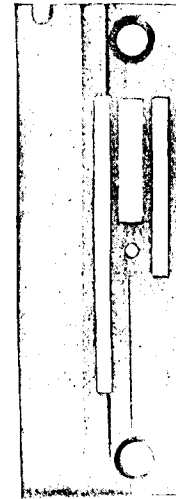
203113



206975



226000



230833



201566



from the library of: Diamond Needle Corp

PLATE 13363-FULL SIZE

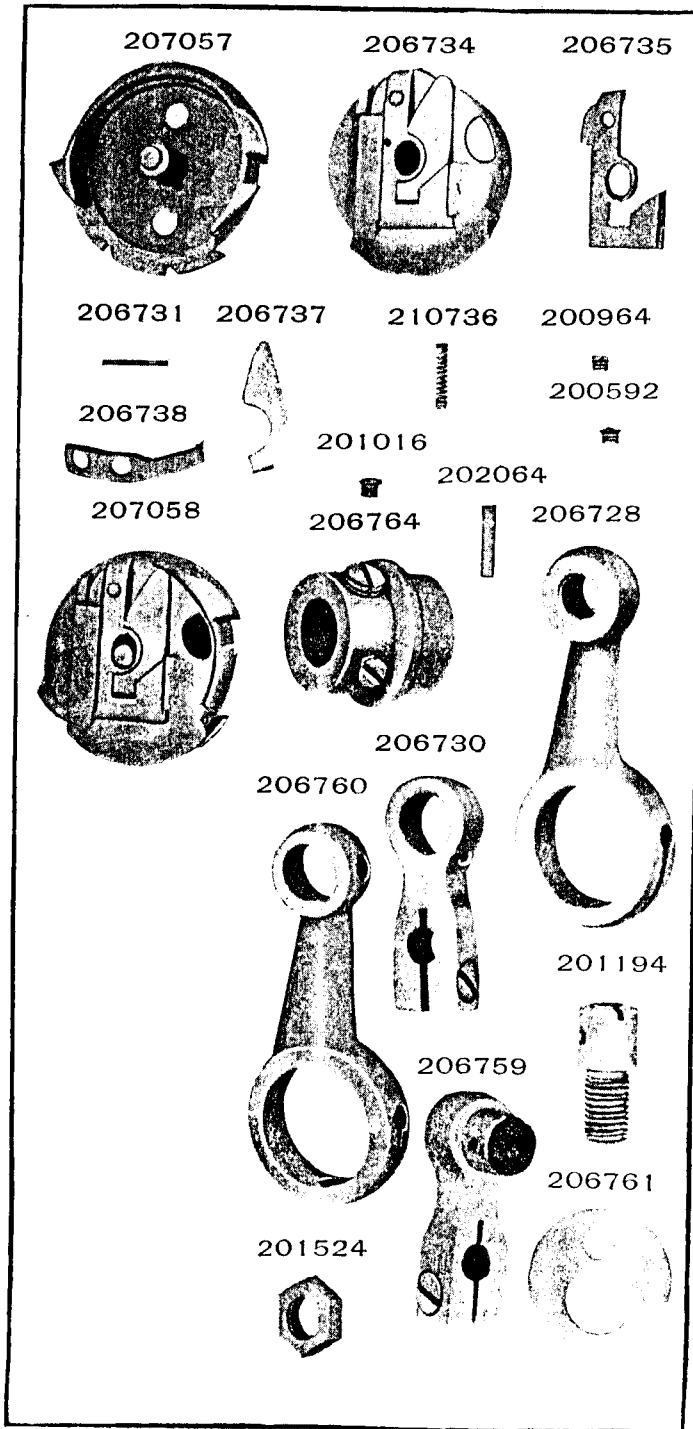
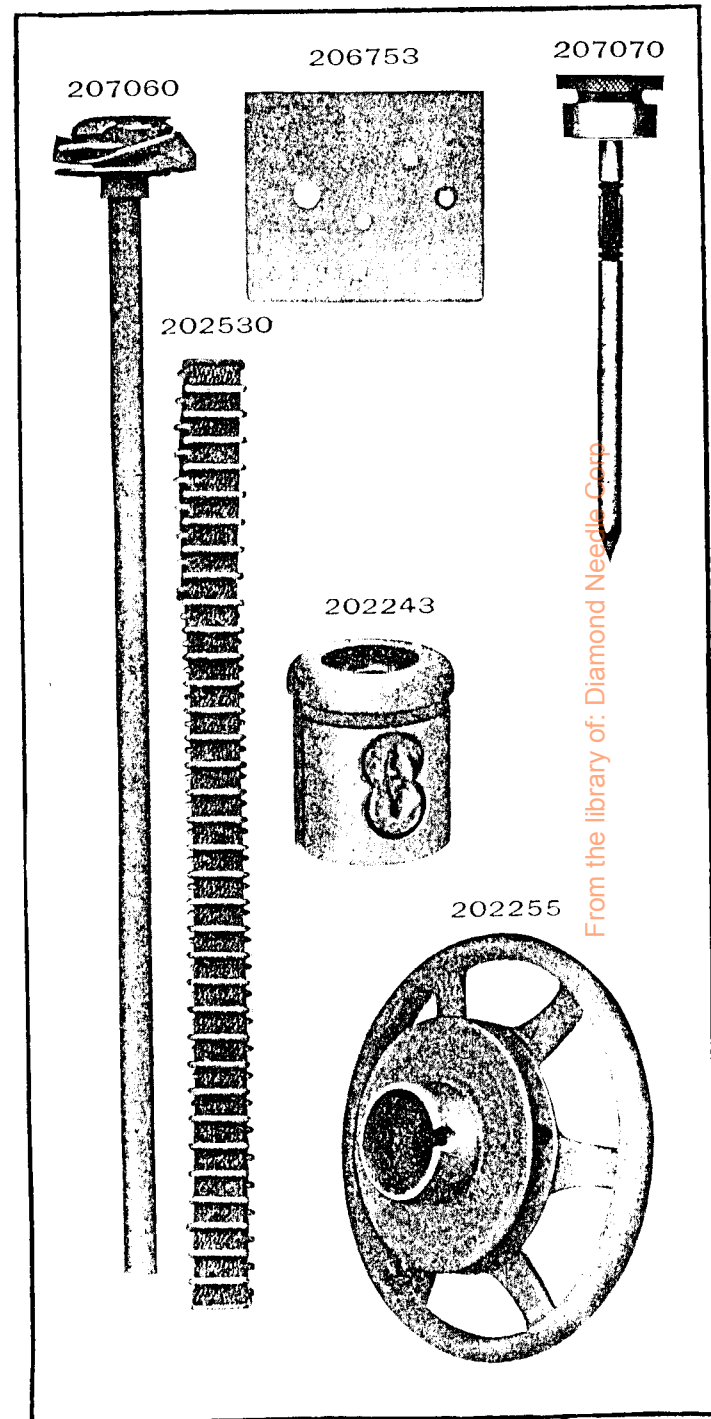


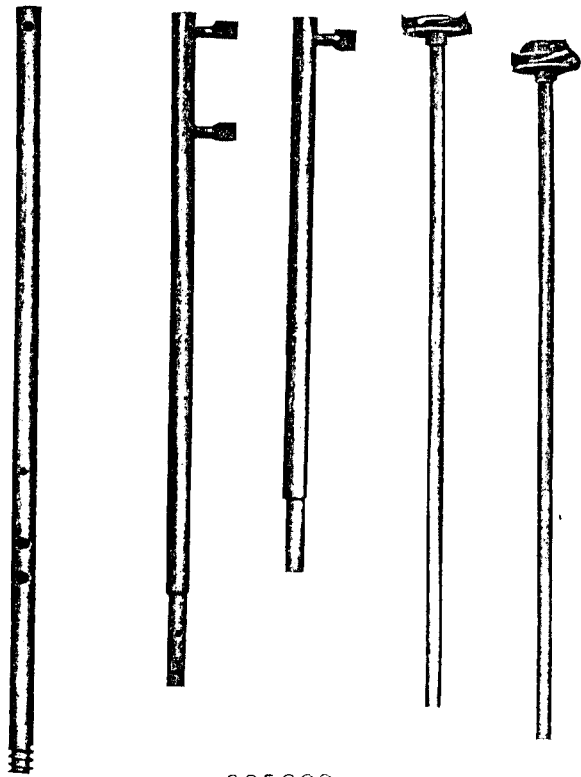
PLATE 13364-ONE-HALF SIZE



From the library of: Diamond Needle Corp

PLATE 13365-ONE-FOURTH SIZE

202250 202304 202654 206754 207061

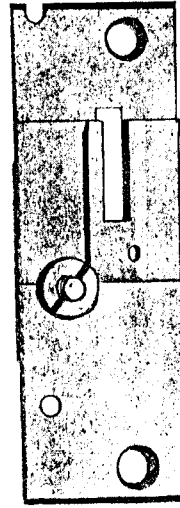


225663

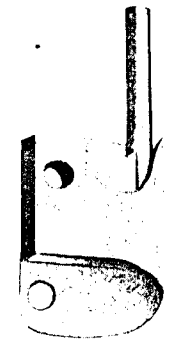


PLATE 14650-FULL SIZE

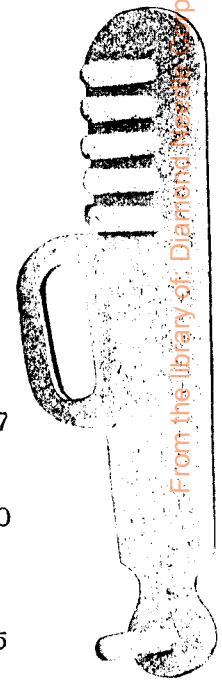
230749



230744



230746



230745



200137



200190



226015



From the library of: [Diamond Systems Corp](#)